

MAZDA

GB	SUNBLINDS Installation Instruction
D	SONNENSCHUTZBLENDE Einbauanleitung
E	PANTALLA SOLAR Instrucciones de montaje
F	RIDEAU Instructions de montage
I	VISIERA PARASOLE Istruzioni di montaggio
P	PALA DE SOL Instruções de montagem
NL	ZONNESCHERM Inbouw-instructie
DK	SOLSKÆRM Monteringsvejledning

N	SOLBESKYTELSESSKJERM Monteringsvejledning
S	SLOSKYDD Monteringsanvisning
SF	AURINKOLIPPA Asennusohje
CZ	SLUNEČNÍ CLONA Návod k montáži
H	NAPELLENZŐ Beszerelési utasítás
PL	OSŁONA PRZECIWSŁONECZNA Instrukcja zabudowy
GR	Αλεξήλιο Οδηγίες τοποθέτησης
RUS	ШТОРКА СОЛНЦА ИНСТРУКЦИЯ ПО УСТАНОВКЕ

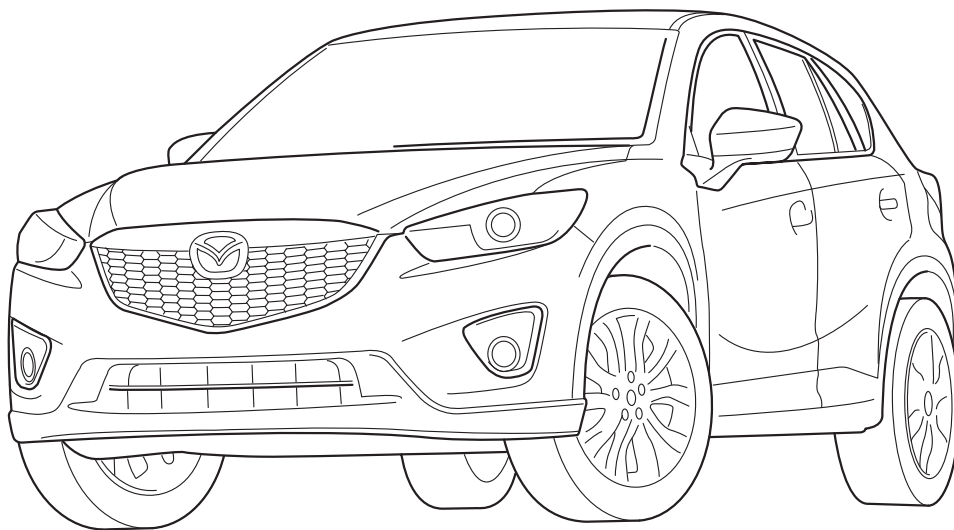

CX-5

KE

Part Number: KD45-V1-132

Date: 01-09-2011

© Copyright MAZDA

Sheet 1 of 5

Expert Fitment Required
Montage durch Fachwerkstatt erforderlich
Montaje sólo por el concesionario
Montage par spécialiste nécessaire
E' necessario in officina specializzata
Especialista em montagem requerido
Montage door vakman nodig
Montage ved professionelt værksted påkrævet
Nødvendig med montering fra fagvegverksted
Verkstadsmontage erfordras
Asennus tarpeen merkkikorjaamossa
Montáž ve specializované dílně nutná
A szereléshez szakműhely kell
Konieczny montaż przez warsztat specjalistyczny
Να τοποθεί απο συνεργείο
Необходима установка специалистами



- (GB) Movement Arrow
- (D) Bewegungspfeil
- (E) Flecha de movimiento
- (F) Flèche indiquant sens du mouvement
- (I) Freccia di movimentov
- (P) Flexa de movimento
- (NL) Richtingspijl
- (DK) Bevægelsespil
- (N) Bevegelsespil
- (S) Rörelsepil
- (SF) Liikesuuntanuoli
- (CZ) Šipka pohybu
- (H) Mozgásirányjelző nyíl
- (PL) Strzałka kierunku ruchu
- (GR) Βέλος κίνησης
- (RUS) Стрелка по направлению



- (GB) Location/Position Arrow
- (D) Positionspfeil
- (E) Flecha de posición
- (F) Flèche de Position
- (I) Freccia di posizione
- (P) Flexa de posição
- (NL) Lokatie/Positie pijl
- (DK) Lokaliseringspil
- (N) Posisjonspil
- (S) Positionpil
- (SF) Paikannusuoli
- (CZ) Šipka na pozici
- (H) Helyzetjelző nyíl
- (PL) Strzałka położenia
- (GR) Βέλος θέσης
- (RUS) Позиция



- (GB) Warning
- (D) Achtung
- (E) Atención
- (F) Attention
- (I) Attenzione
- (P) Atenção
- (NL) Let op
- (DK) Bemærk
- (N) Pass på
- (S) Varning
- (SF) Huomio
- (CZ) Pozor
- (H) Figyelem
- (PL) Uwaga
- (GR) Προσχή
- (RUS) Осторожно

Subject to alteration without notice
 Technische Änderungen vorbehalten
 Reservadas modificaciones técnicas
 Sous réserve de modifications techniques
 Con riserva di apportare modifiche tecniche
 Reservamo-nos o direito a alterações técnicas
 Technische wijzigingen voorbehouden
 Med forbehold for tekniske Índringer
 Tekniske forendringer forbeholdes
 Med reservation för tekniska ändringar
 Tekniset muutokset pidätetään
 Technické zmeny vyhrazeny
 A változtatások technika jogát fenntartjuk
 Zmiany techniczne zastrzeżone
 Επιφύλασσόμεθα για αλλαγές
 Можно изменять без уведомления

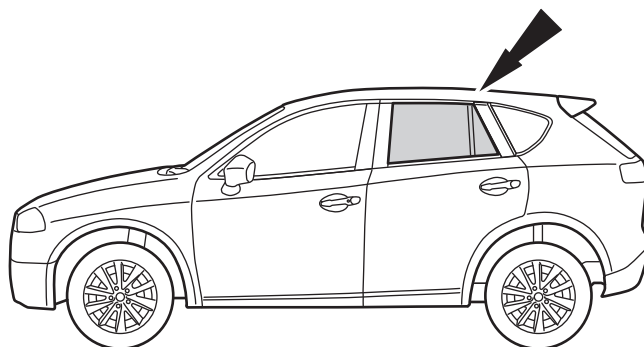

A

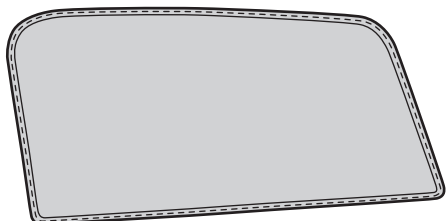

2x

B

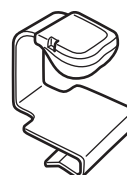

6x

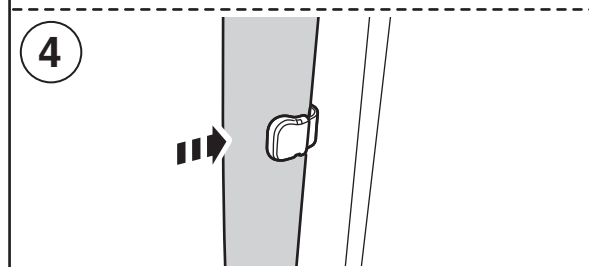
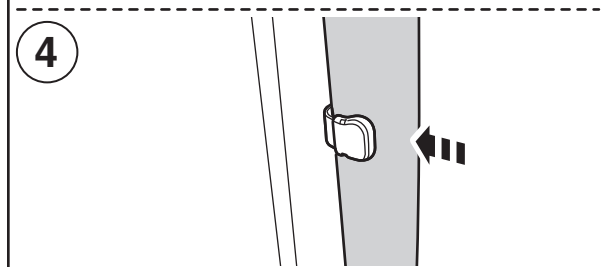
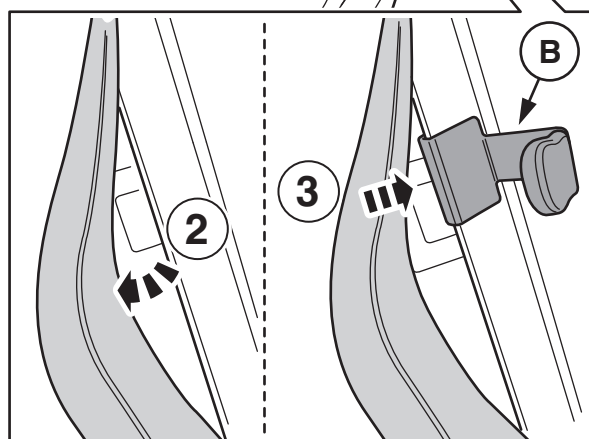
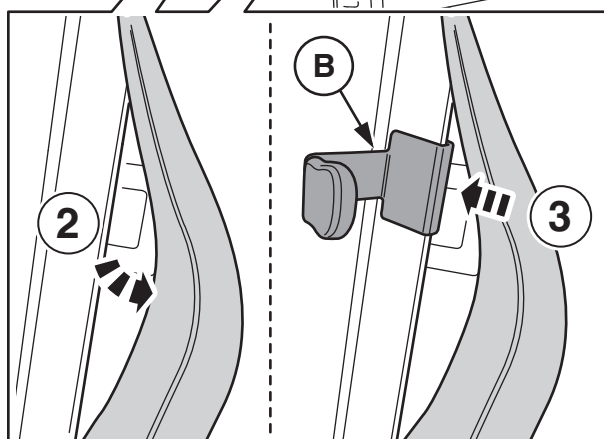
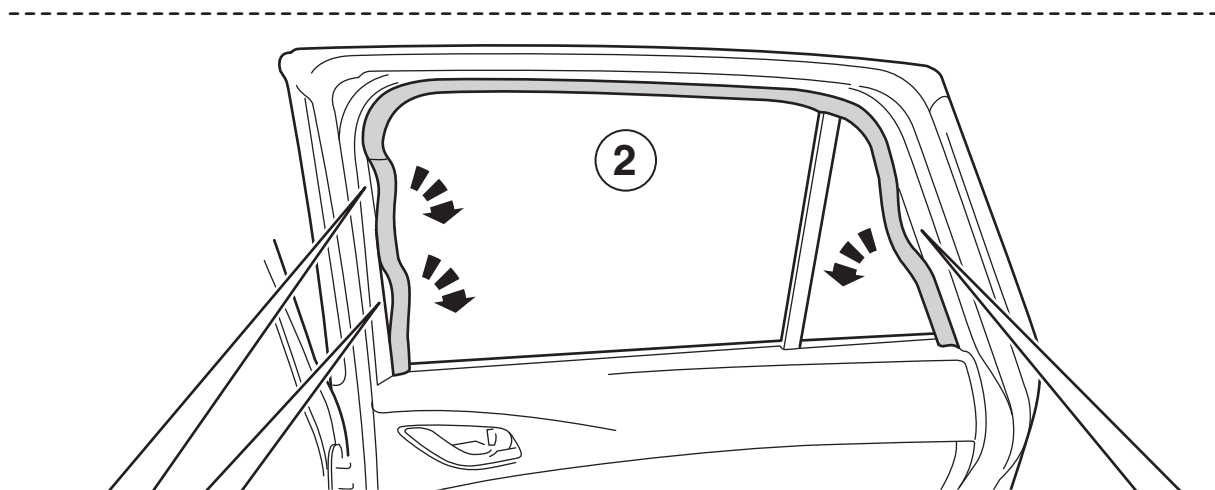
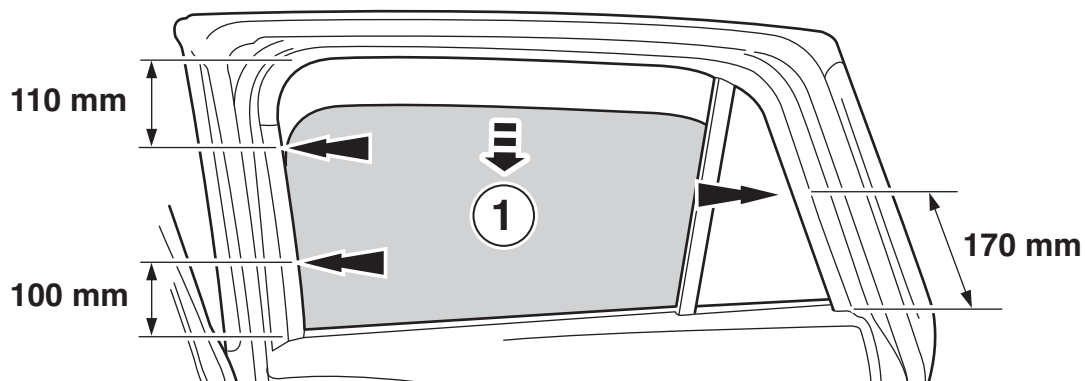

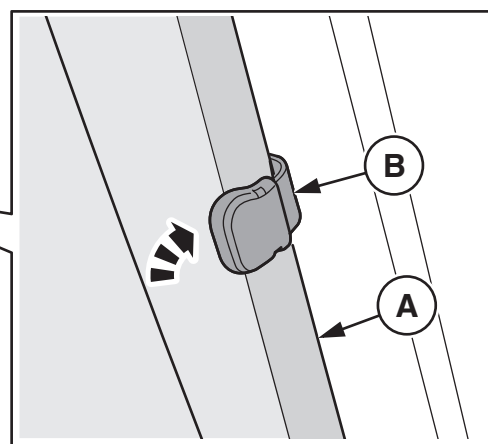
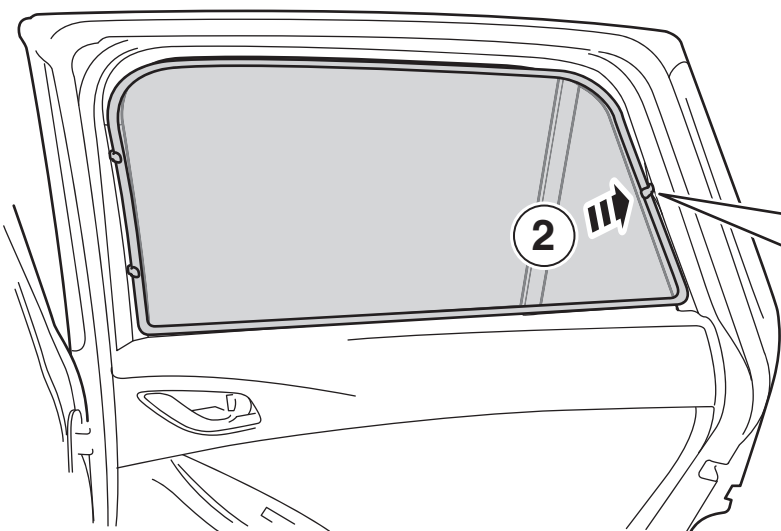
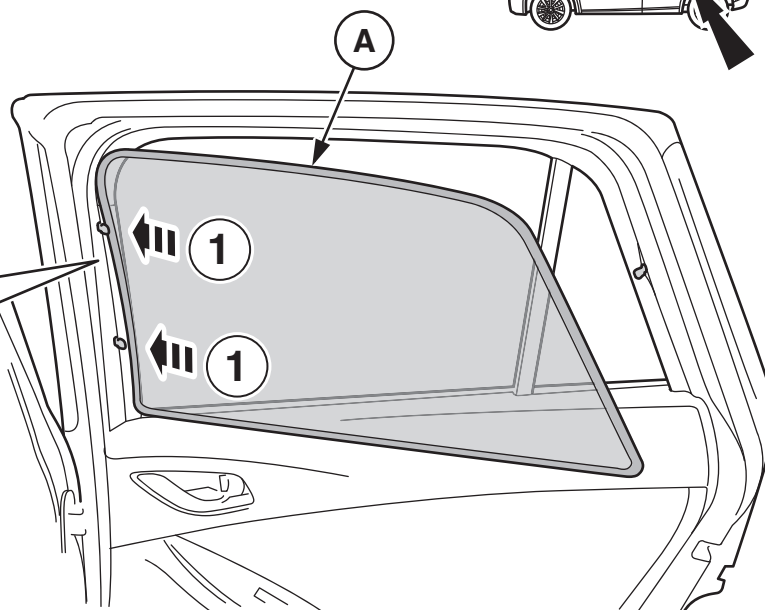
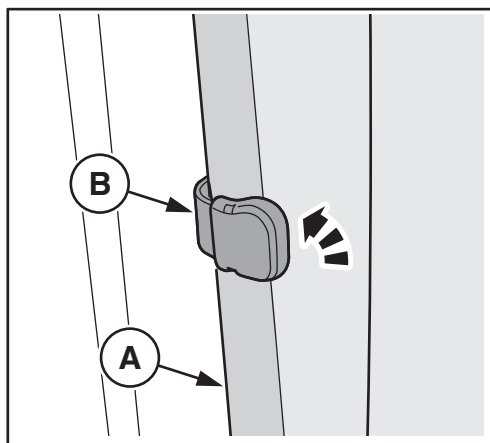

3

