

Tucson (NX4)

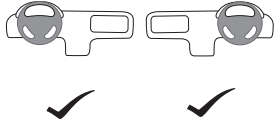

Tucson (NX4)

MY 2021 –



 www.mobisparts.eu

✓ Only for cars with:

POWER WINDOW CONTROL
Driver & Passenger Auto Up / Down

* Example: the actual symbol on the switch may be different.

99651ADE00XX



✓ **Tucson (NX4)** MY 2021 -



 P 3 - 4



 P 6

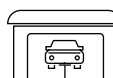
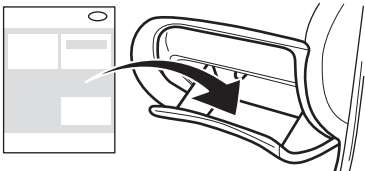

 P 8 - 23

 1.5 hours



(GB)

We expressly point out that assembly not carried out properly by a competent installer will result in cancellation of any right to damage compensation, in particular those arising by virtue of the product liability act.

Contents of these kits and their fitting manuals are subject to alteration without notice, please ensure that these instructions are read and fully understood before commencing installation.

(F)

Nous tenons à insister tout particulièrement sur le fait que si ce produit n'est pas correctement assemblé par un technicien compétent, aucun droit de compensation ne sera recevable en cas de dommages, notamment les droits en vertu de la loi concernant la responsabilité à l'égard des produits.

Le contenu de ce produit, ainsi que des guides de montage qui les accompagnent est sujet à modifications sans préavis; lisez attentivement ces instructions avant de procéder à l'installation.

(D)

Beachten Sie bitte, dass bei Schäden in Folge unsachgemäßen Einbaus sämtliche Garantieansprüche erlöschen.

Das Recht zu Änderungen an Inhalt von Montagesatz und Einbauanleitung ohne Vorankündigung bleibt vorbehalten. Lesen Sie vor dem Einbau diese Anleitung sorgfältig durch.

(E)

Una vez más, hacemos hincapié en el hecho de que si este producto no es instalado correctamente por un técnico cualificado, se anulará cualquier derecho de compensación por posibles daños, especialmente los relativos a la legislación vigente sobre este tipo de productos.

El contenido de los kits y sus correspondientes manuales de montaje están sujetos a posibles modificaciones sin previo aviso. Es importante que lea con atención todas las instrucciones y que las entienda perfectamente antes de iniciar la instalación.

(PT)

Salientamos expressamente que a montagem não realizada por um instalador competente resultará no cancelamento de quaisquer direitos a compensações por danos, particularmente dos resultantes ao abrigo da lei sobre responsabilidade de produtos.

O conteúdo destes kits e os respetivos manuais de instalação estão sujeitos a alteração sem aviso prévio. Certifique-se de que estas instruções são lidas na íntegra e compreendidas antes de se iniciar a instalação.

(I)

Vi informiamo che, in caso di installazione scorretta e/o non eseguita da un installatore competente, il Cliente perderà ogni diritto a un eventuale rimborso danni e, specificamente, ogni diritto previsto dalle leggi sulla responsabilità di prodotto.

I contenuti di questi kit e i relativi manuali di installazione sono soggetti a modifica senza preavviso. Si raccomanda di leggere attentamente e integralmente tali istruzioni e di sincerarsi di averle comprese prima di procedere all'installazione.

(NL)

De installatie moet worden uitgevoerd door een erkende, competente installateur. Incorrecte montage kan leiden tot het vervallen van elk recht op schadecompensatie, met name die met betrekking tot product aansprakelijkheid.

De inhoud van deze kits en de installatiehandleidingen kunnen worden gewijzigd zonder kennisgeving. Zorg er voor, dat u deze instructies hebt gelezen en volledig begrijpt voordat u met de installatie begint.

(S)

Vi meddelar att montering, som inte görs fackmannamässigt, kommer att häva rätten till kompensation för skador, speciellt rättigheter enligt lagen om produktansvar.

Innehållet i dessa satser och deras bruksanvisningar kan komma att ändras utan förvarning. Vänligen läs dessa anvisningar noga innan du påbörjar monteringen.

(N)

Vi bemerker at montasje som ikke utføres korrekt, av en kompetent installatør, vil resultere i annullering av all rett til erstatning for enhver skade, spesielt de som oppstår av arten produktansvar.

Innholdene i disse sett og deres monteringsanvisninger kan endres uten forvarsel. Vennligst påse at disse instruksjonene leses grundig og er forstått innen installasjonen startes.

(DK)

Det skal understreges, at montering, der udføres af en ikke-kvalificeret montør, medfører bortfald af enhver ret til erstatning særligt i forbindelse med erstatnings-krav, der måtte opstå i kraft af loven om produktansvar. Sættenes indhold og monteringsvejledninger kan ændres uden varsel, og vejledningerne skal derfor læses og forstås, før monteringen påbegyndes.

(FIN)

Jos asennuksen suorittaa joku muu kuin pätevä ammattilainen, tämä kumoo asiakkaan oikeuden vahingonkorvauksiin, erityisesti sellaisiin, jotka perustuvat tuotevastuulakiin.

Kiinnityssarjan sisältöä ja asennusohjeita voidaan muuttaa siittä etukäteen ilmoittamatta. Näihin ohjeisiin tulee perehtyä huolellisesti ennen asennuksen aloittamista.

(CZ)

Upozorňujeme, že instalace provedená nesprávně nebo nekompetentní osobou, ruší veškerá práva na kompenzaci škod, obzvláště tech způsobených poruchou produktu.

Obsah těchto sad a návody na jejich montáž podléhají změnám bez předchozího upozornění. Prosím, ujistěte se, že jste si pokyny před instalací přečetly a dostatečně jim rozumíte.

(PL)

Pragniemy wyraźnie podkreślić, że nieprawidłowy montaż przeprowadzony przez niekompetentne osoby będzie podstawą rezygnacji z ewentualnego prawa do odszkodowania, w szczególności wynikających z mocy ustawy o odpowiedzialności za produkt.

Zawartość opisywanych zestawów i instrukcje ich montażu mogą ulec zmianie bez uprzedzenia; przed rozpoczęciem instalacji należy zapoznać się z instrukcjami i upewnić się, że zostały w pełni zrozumiałe.

(SK)

Upozorňujeme, že inštalácia vykonaná nesprávne alebo nekompetentnou osobou, ruší všetky práva na kompenzáciu škôd, obzvlášť tých spôsobených poruchou produktu.

Obsah týchto sad a návody na ich montáž podliehajú zmenám bez predchádzajúceho upozornenia. Prosím, uistite sa, že ste si pokyny pred inštaláciou prečítali a dostatočne ste im porozumeli.

(RO)

Vă atragem atenția că montajul efectuat incorect sau de către personal neautorizat duce la anularea oricărei drept de compensare a eventualelor daune produse utilizatorului.

Conținutul acestor pachete precum și al instrucțiunilor de montaj pot fi modificate fără preaviz. Vă rugăm să vă asigurați că aceste instrucțiuni sunt citite și înțelese înainte de a începe instalarea.

(BG)

Изрично посочваме, че при монтиране, което не се осъществява правилно от компетентен монтьор, ще последва отмяна на всякакви права за обезщетение за нанесени вреди, по-специално тези, произтичащи въз основа на закона за отговорност за вреди. Съдържанието на тези комплекти и техните монтажни ръководства подлежат на изменения без предизвестие.

Моля, уверете се, че инструкциите са прочетени и напълно разбрани преди започване на монтажната дейност.

(EST)

Juhime tähelepanu sellele, et ebakorrektnete ja ebapädevate paigaldajate tehtud montaaž tühistab õiguse esitada kahjunõudeid, eelkõige tootevastutusseaduse alusel esitatavaid nõudeid.

Nende komplektide ja paigaldusjuhendite sisu võidakse ette teatamata muuta, mistõttu tuleb juhised enne paigalduse alustamist läbi lugeda ja neist täielikult aru saada.

(HR)

Izričito naglašavamo da će montaža koju ne provodi ovlaštení instalater rezultirati otkazivanjem svih prava na naknadu štete, osobito onih koja se temelje na zakonskim propisima o odgovornosti za proizvode.

Sadržaj ovih kompleta i njihovih priručnika za pričvršćivanje podložni su izmjeni bez prethodne obavijesti, pažljivo pročitajte s razumijevanjem ove upute prije započinjanja s instalacijom.



www.mobisparts.eu



(HU)

Kifejezetten felhívjuk a figyelmét, hogy a nem megfelelően, hozzáértő szakember által végzett összeszerelés a kártérítésre vonatkozó valamennyi jog elvesztését eredményezi, különös tekintettel a termékgaranciáról szóló törvények biztosította jogokra. A készletek és a felhelyezési útmutatók tartalma külön értesítés nélkül változhat, ezért a szerelés megkezdése előtt mindenképp gondosan tanulmányozza át és értelmezze az utasításokat.

(LAT)

Mēs īpaši norādām uz to, ka gadījumos, kad aplimēšanu nebūs pareizi veicis kompetents tehniķis, jebkādas tiesības uz zaudējumu atlīdzību tiks anulētas, jo īpaši tādas, ko pamato produktu drošumatbildības likums. Šo komplektu un to uzlīmēšanas rokasgrāmatu saturs var tikt mainīts bez iepriekšēja paziņojuma, lūdzu, nodrošiniet, lai pirms līmēšanas sākšanas šie norādījumi būtu izlasīti un pilnībā izprasti.

(LIT)

Mes aiškiai nurodome, kad, jei montavimas nėra tinkamai atliktas kompetentingo montuotojo, nesuteikiamos jokios teisės į žalos kompensavimą, ypač tos, kurios išplaukia iš gaminio atsakomybės akto. Šių rinkinių turinys ir jų įrengimo vadovai gali būti keičiami nepranešus, užtikrinkite, kad prieš pradėdant įrengimo darbus būtų perskaitytos ir visiškai suprastos šios instrukcijos.

(GB)

Both the vehicle and the workshop are required to have a temperature between 65° and 104°F.

(F)

Le véhicule et l'atelier doivent avoir une température comprise entre 18° et 40°C.

(D)

Die Temperatur von Fahrzeug und Werkstatt soll zwischen 18° and 40°C liegen.

(E)

Mantener el vehículo y el área de trabajo en un rango de temperaturas entre 18° y 40°C.

(PT)

Tanto o veículo como a oficina têm de estar a uma temperatura entre 18° e 40°C.

(I)

Sia il veicolo che l'officina dovranno avere una temperatura compresa tra 18° e 40°C.

(NL)

Zowel voertuig als werkplaats moeten een temperatuur hebben tussen 18° en 40°C.

(S)

Både fordonet samt verkstaden skall hålla en temperatur mellan 18° - 40°C.

(N)

Både kjøretøyet og verkstedet er nødvendig for å ha en temperatur mellom 18° og 40°C.

(SER)

Posebno ističemo da će montaža koju nije obavio kvalifikovani montažer, imati za posledicu poništavanje svih prava na obeštećenje, a posebno onog koje proističe iz odluke o odgovornosti za proizvod. Sadržaj ovih kompleta i pripadajućih uputstava podleže izmenama bez upozorenja, molimo vas da se postarate da se ova uputstva pročitaju i u potpunosti razumeju pre početka instalacije.

(SVN)

Izrecno opozarjamo, da bo montaža, ki ne bo izvedena ustrezno s strani pristojnega monterja, povzročila razveljavitev kakršnih koli pravic do odškodnine, zlasti tistih, ki izhajajo iz zakona o odgovornosti za izdelek. Vsebina kompletov in priložnikov za vgradnjo je predmet sprememb brez predhodnega obvestila. Prepričajte se, da bodo izvajalci pred pričetkom vgradnje navodila prebrali in razumeli.

(UKR)

Наголошуємо на тому, що роботи мають здійснюватися належним чином і виключно вповноваженим виконавцем. В іншому випадку будь-які права на відшкодування збитків, зокрема ті, які виникають згідно із законодавством про відповідальність виробника за якість продукції, вважаються недійсними. Вміст цих комплектів і відповідні інструкції можуть бути змінені без попередження. Не розпочинайте роботи, якщо ви не прочитали та не зрозуміли повною мірою ці інструкції.

(ICE)

Við bendum gagnert á að ef samsetningin er ekki almennilega gerð af aðila sem er með viðeigandi þjálfun getur rétturinn á skaðabótum vegna skemmda, sérstaklega skaðabótum varðandi reglur um vöruábyrgð, orðið ógildur. Innihald settanna og uppsetningarleiðbeiningar geta breyst án fyrirvara. Vinsamlegast tryggjið að þessar leiðbeiningarnar séu lesnar og fullur skilningur til staðar áður en uppsetning hefst.

(GR)

Θα πρέπει να τονιστεί ότι συναρμολόγηση που δεν πραγματοποιείται σωστά και από ειδικευμένο εγκαταστάτη οδηγεί σε ακύρωση των όποιων δικαιωμάτων αποζημίωσης έναντι ζημίας και ιδιαίτερα αυτών που προκύπτουν σύμφωνα με το νόμο περί ευθύνης προϊόντος. Τα περιεχόμενα αυτών των κит και τα εγχειρίδια τοποθέτησης υπόκεινται σε αλλαγές χωρίς προειδοποίηση. Βεβαιωθείτε ότι ο οδηγός αυτές έχουν διαβάσει και έχουν γίνει απολύτως κατανοητές προτού ξεκινήσετε την εγκατάσταση.

(RUS)

Обратите внимание, что при повреждениях, возникших в результате неправильного монтажа, истекают все виды гарантии, в частности, касающиеся закона, регулирующего ответственность за качество продукции. Производитель сохраняет за собой право на изменение содержания монтажного комплекта и инструкции по установке без предварительного уведомления. Внимательно прочитайте инструкцию перед началом установки.



18° - 40°C
65° - 104°F

(DK)

Både bilen og værkstedet skal under hele arbejdet have en temperatur i mellem 18° og 40° grader C.

(FIN)

Toimenpiteen aikana tulee sekä ajoneuvon että asennustilan lämpötilan olla 18° ja 40°C asteen välillä.

(CZ)

Vozidlo i dílna by při instalaci měli být temperovány mezi 18° až 40°C.

(PL)

Temperatura nadwozia samochodu, jak i temperatura powietrza w warsztacie, muszą się mieścić w zakresie 18° - 40°C.

(SK)

Vozidlo, taktiež aj dielňa, by mali mať teplotu od 18° do 40°C.

(RO)

Temperatura din atelier și temperatura vehicului trebuie să se încadreze între 18° și 40°C.

(BG)

Необходимо е температурата на автомобила, както и на сервиза да бъде между 18°C и 40°C.

(EST)

Nii sõiduki kui ka töökoja temperatuur peab olema vahemikus 18° - 40°C.

(HR)

Temperatura u vozilu i radionici treba biti između 18° i 40°C.

(HU)

A jármű és a műhely hőmérsékletének egyaránt 18°C és 40°C közé kell esnie.

(LAT)

Gan transportlīdzekļa temperatūrai, gan temperatūrai darbnīcā jābūt starp 18° un 40°C.

(LIT)

Tiek mašinos, tiek dirbtuvių aplinkos temperatūra turi būti nuo 18° iki 40°C.

(SER)

Zahteva se da i vozilo i radionica budu na temperaturi između 18° i 40°C.

(SVN)

Temperatura vozila in delavnice mora biti med 18°C in 40°C.

(UKR)

Температура автомобіля та повітря в майстерні має бути в межах 18° - 40°C.

(ICE)

Hitastig ökutækisins og verkstæðisins á að vera 18° - 40°C.

(GR)

Τόσο το όχημα όσο και το συνεργείο θα πρέπει να έχουν θερμοκρασία μεταξύ 18° και 40°C.

(RUS)

Температура автомобиля и помещения должна быть от 18° до 40°C.

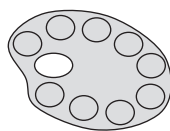

	BK	BN	BU	GY	GN	WH	YE	OG	PE	PI	RD
(GB)	Black	Brown	Blue	Grey	Green	White	Yellow	Orange	Purple	Pink	Red
(F)	Noir	Marron	Blue	Gris	Vert	Blanc	Jaune	Orange	Violet	Rose	Rouge
(D)	Schwarz	Braun	Blau	Grau	Grün	Weiß	Gelb	Orange	Violett	Rosa	Rot
(E)	Negro	Marrón	Azul	Gris	Verde	Blanco	Amarillo	Naranja	Morado	Rosa	Rojo
(PT)	Preto	Castanho	Azul	Cinzentos	Verde	Branco	Amarelo	Laranja	Roxa	Rosa	Vermelho
(I)	Nero	Marrone	Blu	Grigio	Verde	Bianco	Giallo	Arancione	Viola	Rosa	Rosso
(NL)	Zwart	Bruin	Blauw	Grijs	Groen	Wit	Geel	Oranje	Paars	Roze	Rood
(S)	Svart	Brun	Blå	Grå	Grön	Vit	Gul	Orange	Lila	Rosa	Röd
(N)	Svart	Brun	Blå	Grå	Grønn	Hvit	Gul	Oransje	Lilla	Rosa	Rød
(DK)	Sort	Brun	Blå	Grå	Grøn	Hvid	Gul	Orange	Lilla	Pink	Rød
(FIN)	Musta	Ruskea	Sininen	Harmaa	Vihreä	Valkoinen	Keltainen	Oranssi	Purppura	Vaaleanpunainen	Punainen
(CZ)	Černá	Hnědá	Modrá	Šedá	Zelená	Bílá	Žlutá	Oranžová	Fialová	Růžová	Červená
(PL)	Czarny	Brązowy	Niebieski	Szary	Zielony	Biały	Żółty	Pomarańczowy	Purpurowy	Różowy	Czerwony
(SK)	Čierna	Hnedá	Modrá	Sivá	Zelená	Biela	Žltá	Oranžová	Fialová	Ružová	Červená
(RO)	Negru	Maro	Albastru	Grey	Verde	Alb	Galben	Portocale	Violet	Roz	Roșu
(BG)	черно	кафяв	син	сив	зелен	бял	жълт	оранжев	лилаво	розов	червен
(EST)	must	pruun	sinine	hall	roheline	valge	kollane	oranž	lilla	roosa	punane
(HR)	crno	smeđ	plava	siva	zelena	bijela	žuta boja	narančasta	purpurna boja	ružičasta	Crvena
(HU)	fekete	barna	kék	szürke	zöld	fehér	sárga	narancs	lila	rózsaszín	piros
(LAT)	melns	brūna	zils	pelēks	zaļš	balts	dzeltens	apelsīns	violeti	sārts	sarkans
(LIT)	juoda	rudá	mėlynas	pilka	žalias	balta	geltona	oranžinė	violetinė	rožinis	raudona
(SER)	црн	браон	Плави	сива	зелен	бео	жуто	наранџаста	љубичаста	розе	црвена
(SVN)	Črna	rjav	modra	siva	zelena	bela	rumeno	oranžna	vijolična	roza	rdeča
(UKR)	чорний	коричневий	синій	сірий	зелений	білий	жовтий	апельсин	фіолетовий	рожевий	червоний
(ICE)	svartur	brúnn	blár	grár	grænn	hvítur	gult	appelsínugult	fjólublátt	bleikur	rautt
(GR)	Μαύρο	Καφέ	Μπλε	Γκρι	Πράσινο	Λευκό	Κίτρινο	Πορτοκαλί	Μοβ	Ροζ	Κόκκινο
(RUS)	черный	Коричневый	синий	серый	зеленый	белый	желтый	оранжевый	пурпурный	розовый	красный

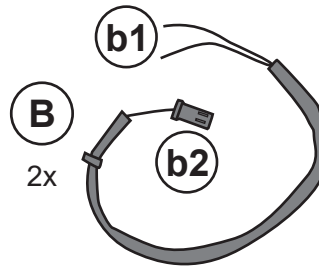
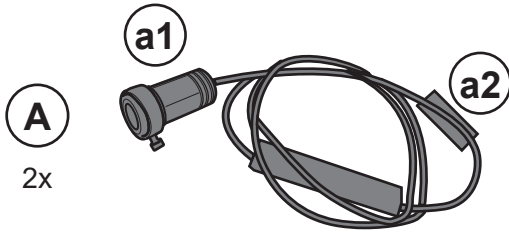
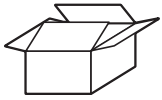
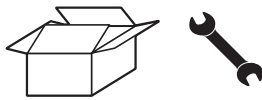

C		D		E		F	
1x	Ø 19 mm	4x	Ø	10x		4x	

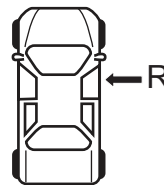
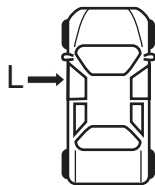
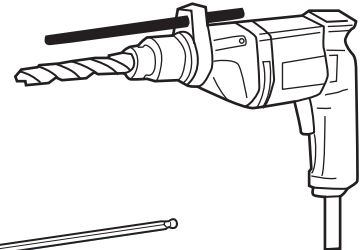
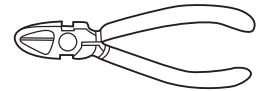
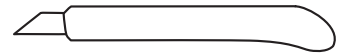
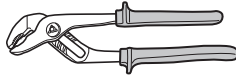
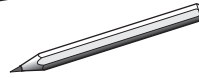
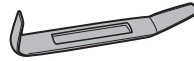
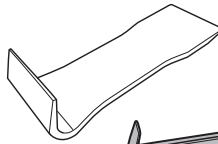
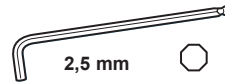
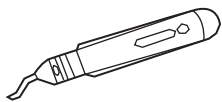
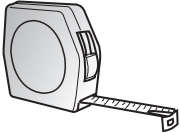
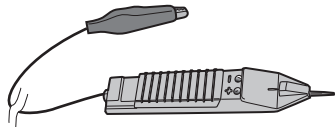
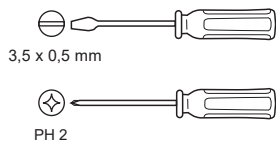

18° - 40°C
65° - 104°F

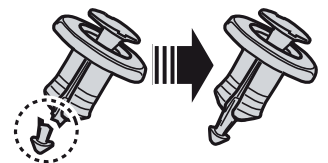

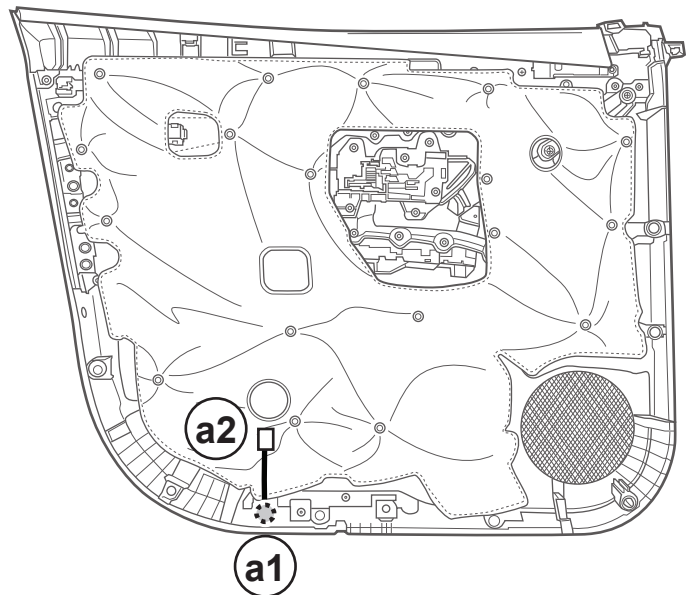
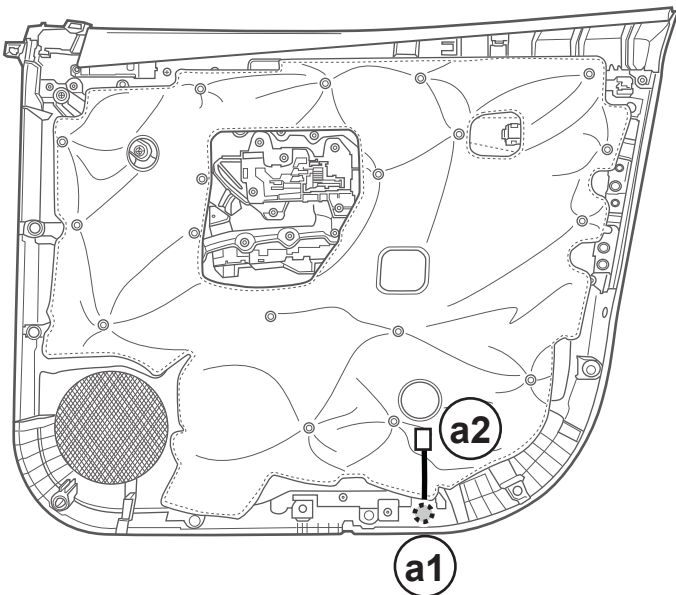
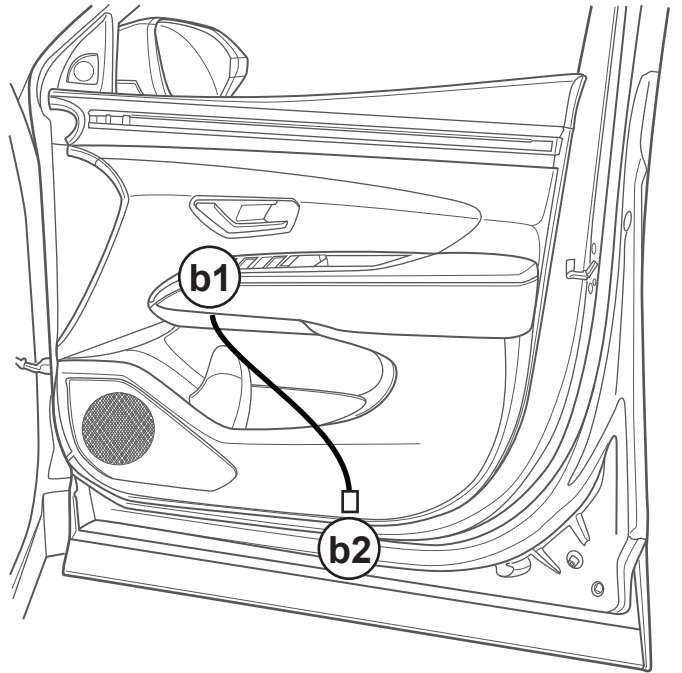
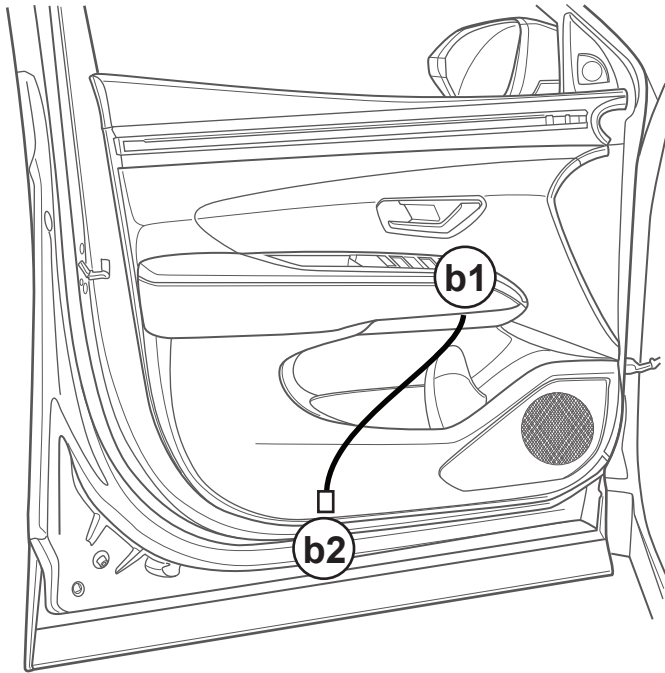
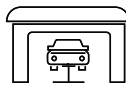

ROUTING



L & R

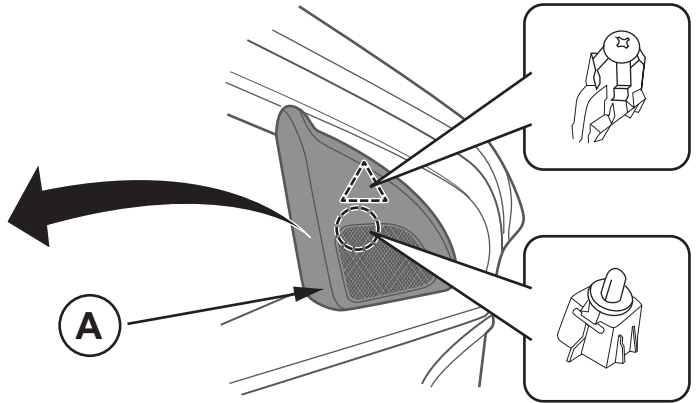
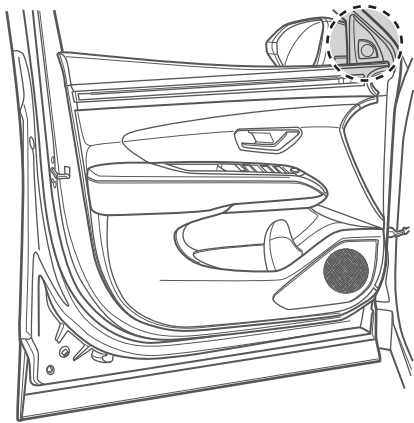
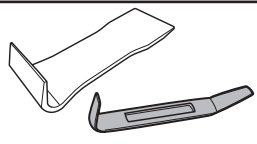

Fig 1

L & R

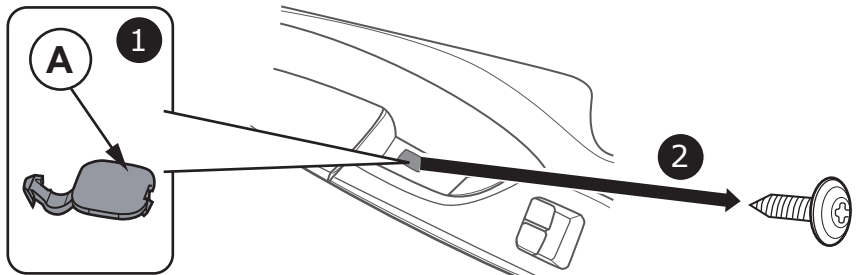
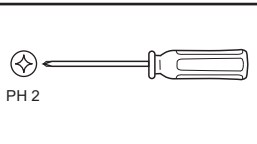
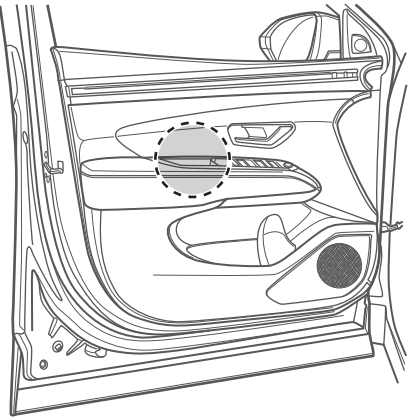

Fig 2

L & R

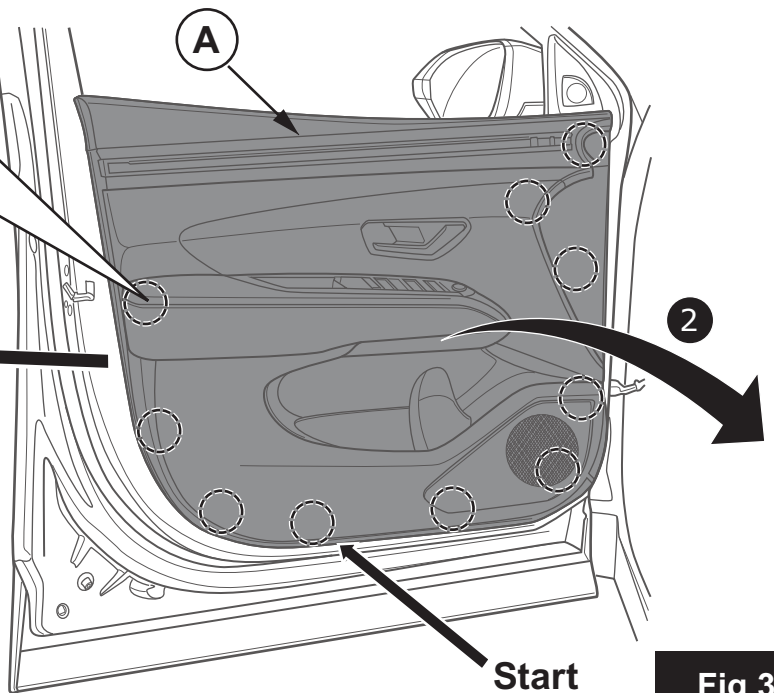
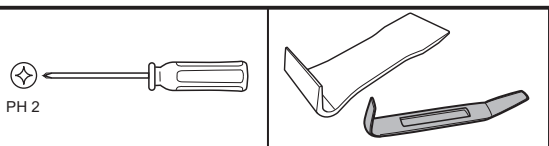
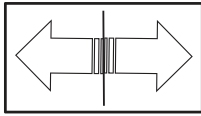

Fig 3



L & R



1

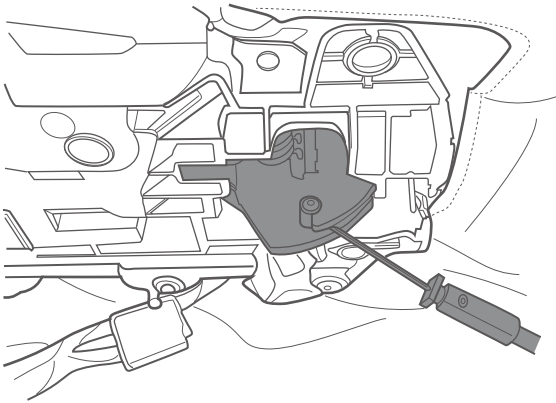

2

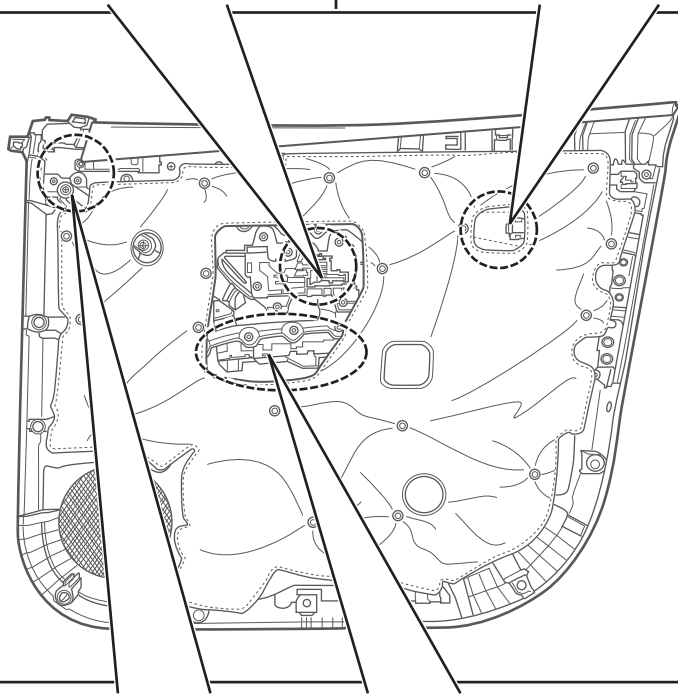
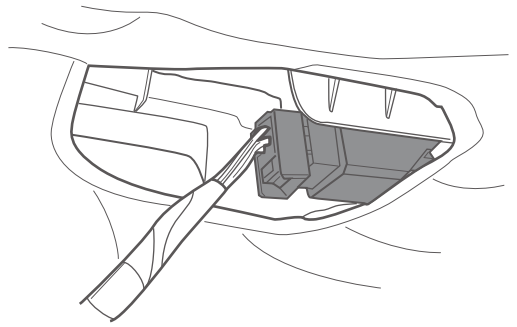

3

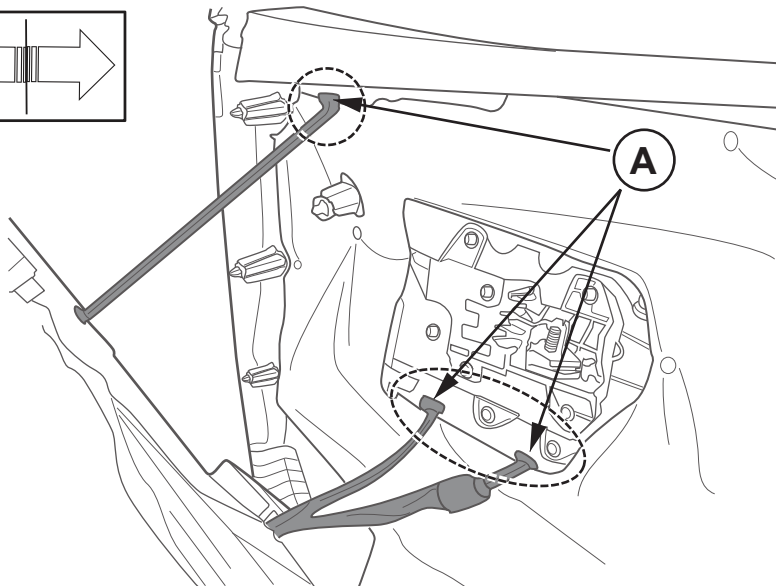
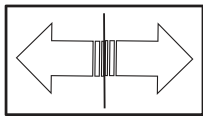

Fig 4



Example: Power window system

A

Global Service Way | VIN: TMAJE81BHMJ000167

Model ID : TUCSON(NX4e) Model Year : 2021 Engine : [HME] TUCSON(NX4e) // 2021 // G 1.6 T-GDI GAMMA II MHEV

Shop Manual ETM DTC Guide Symptom Component Body Repair SST OVERHAUL Owners Manual PTI

B

Global Service Way | VIN: TMAJE81BHMJ000167

Model ID : TUCSON(NX4e) Model Year : 2021 Engine : [HME] TUCSON(NX4e) // 2021 // G 1.6 T-GDI GAMMA II MHEV

Shop Manual **ETM** DTC Guide Symptom Component Body Repair SST OVERHAUL Owners Manual PTI

ETM Thumbnail Original

ETM Passenger English TUCSON(NX4e) 2021 G 1.6 T-GDI GAMMA II GO

C

Shop Manual ETM DTC Guide Symptom Component Body Repair SST OVERHAUL Owners Manual

ETM Passenger English TUCSON(NX4e) 2021 G 1.6 T-GDI GAMMA II MHEV GO

G 1.6 T-GDI GAMMA II MHEV

- General
- Component Locations
- Components Index
- Connector View
- Harness Layouts
- Schematic Diagrams**
- DCT(Double Clutch Transmission) System
- 4 Wheel Drive (4WD) System
- Battery Control System
- Body Electrical System**
- A/V & Navigation
- Power Outlet & USB Charge Connector System
- Power Outside Mirror System
- Power Seat System
- Power Tailgate System
- Power Window System**
- With Driver Window Auto Down
- With Driver Safety Window
- With Front Safety Window**
- With Front/Rear Safety Window
- Service Tips
- Rear Occupant Alert (ROA) System
- Seat Warmer System
- Stop Lamps
- Sunroof System
- Tail, Parking & License Lamps

2021 > G 1.6 T-GDI GAMMA II MHEV > G 1.6 T-GDI GAMMA II MHEV > Schematic Diagrams > Body Electrical System

Power Window System (7) SDR24-7

With Front Safety Window (1/3)

Fig 5

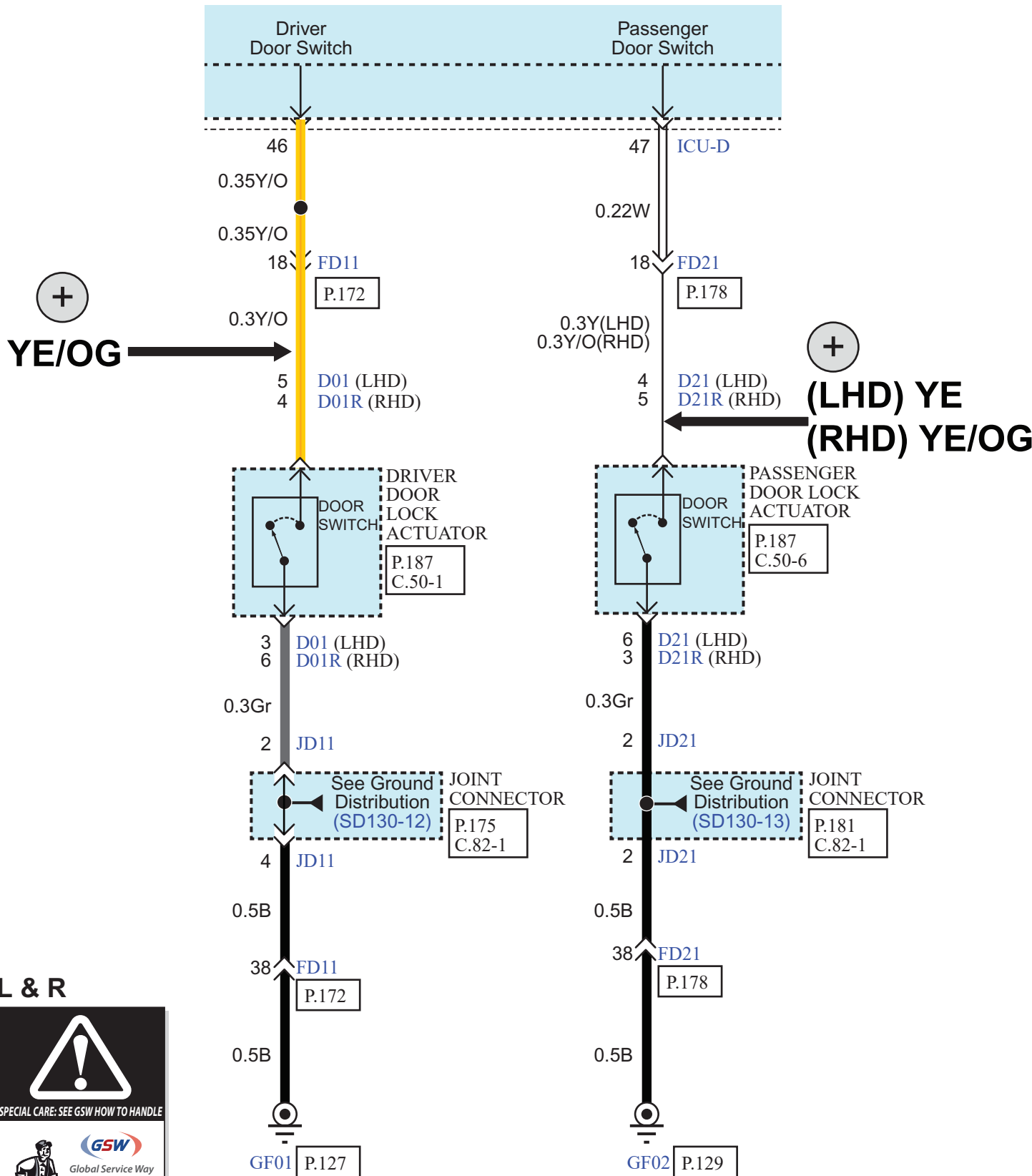
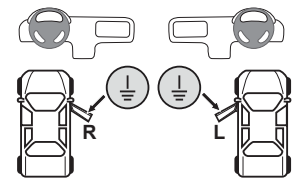
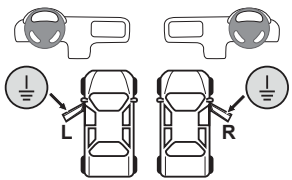

L & R

SPECIAL CARE: SEE GSW HOW TO HANDLE

Fig 6

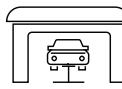

L & R

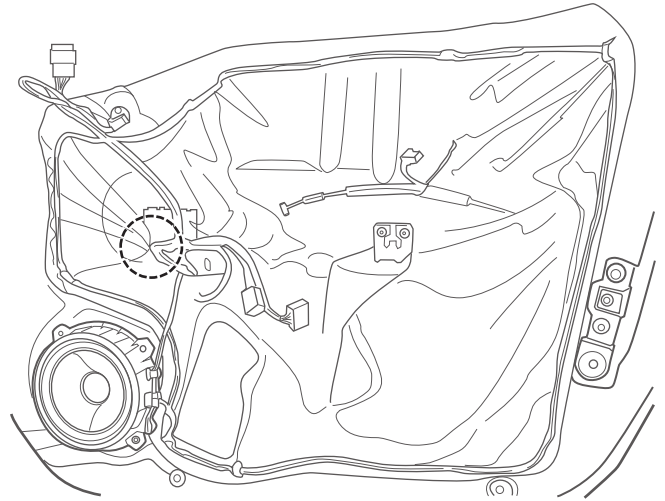
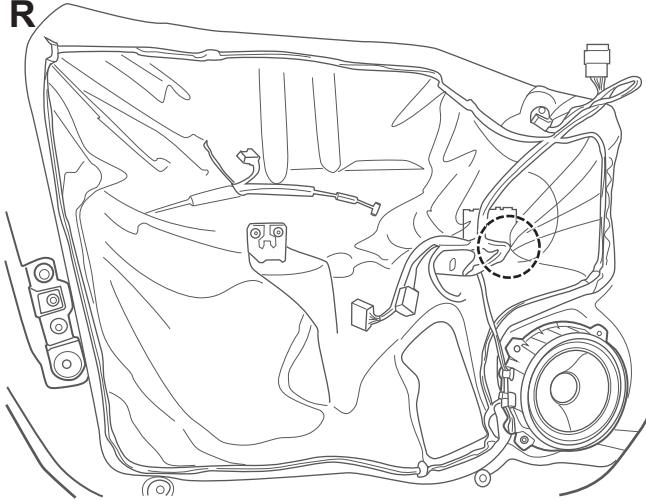

1

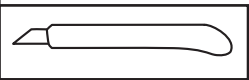
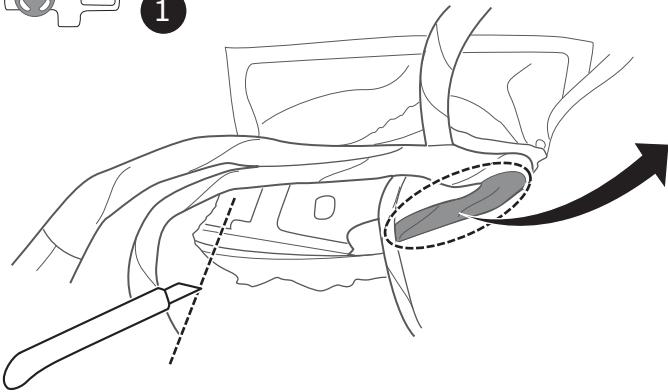

2

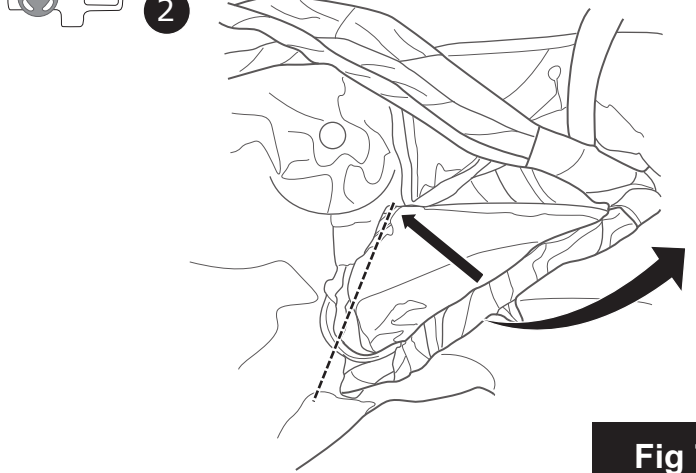
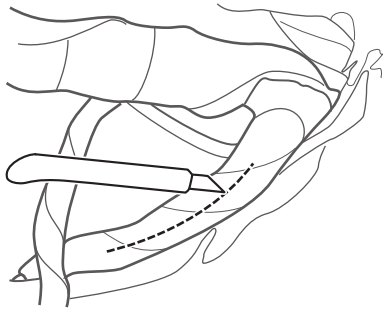

Fig 7

L & R



1



2

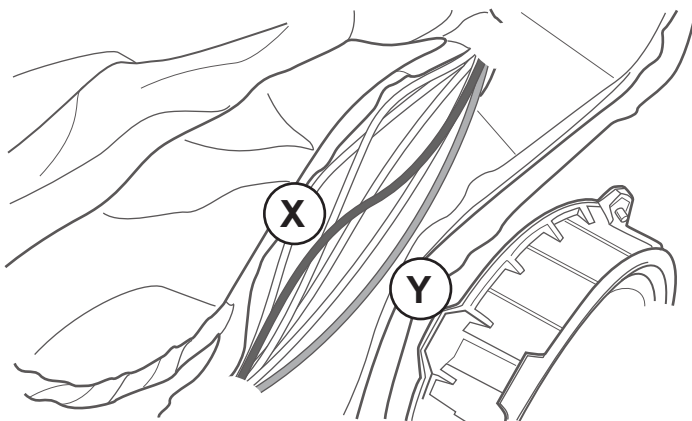

- (X) | YE/OG
- (Y) | WH

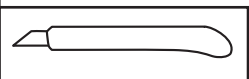

Fig 8

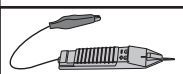
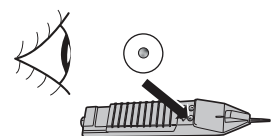
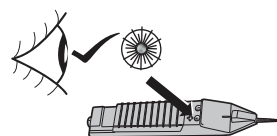
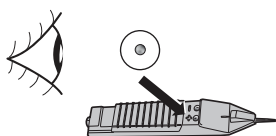
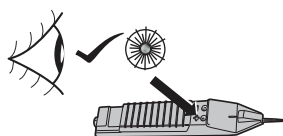
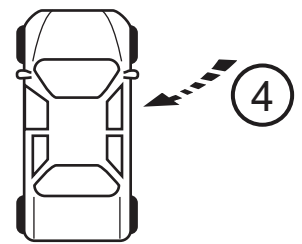
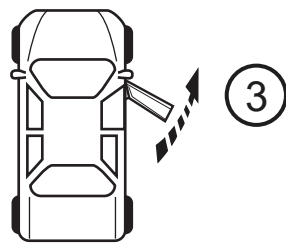
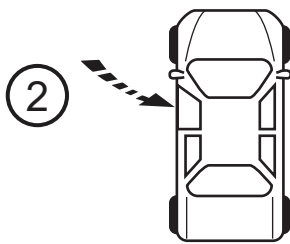
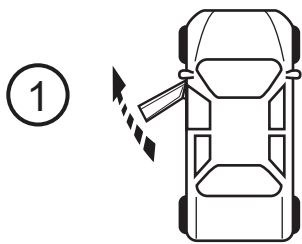
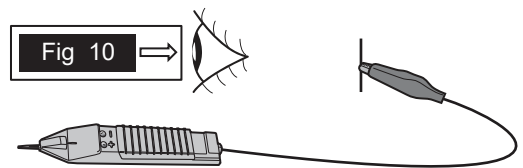
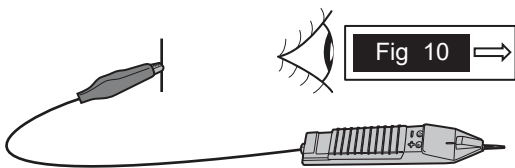
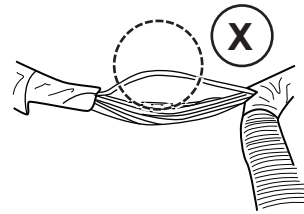
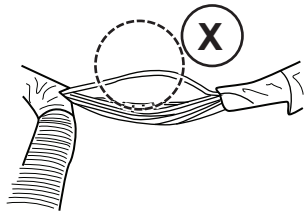
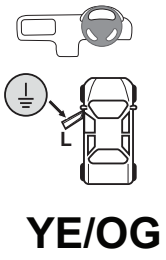
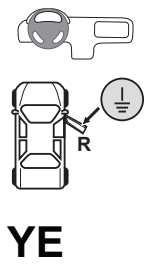
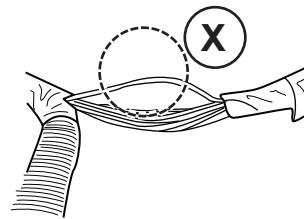
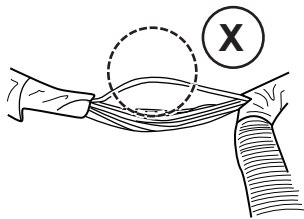
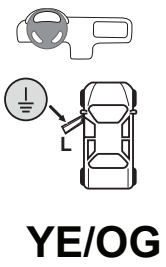
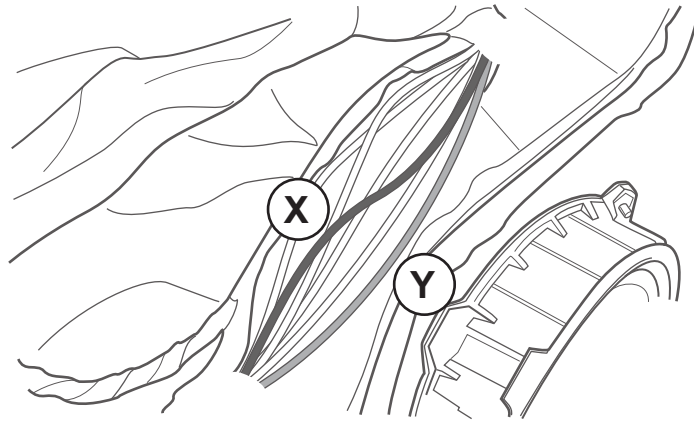
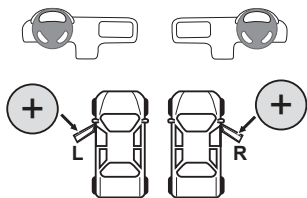
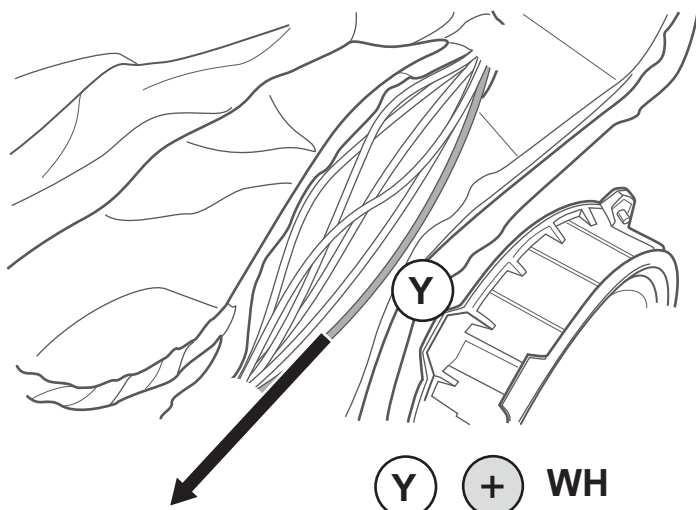

Fig 9



L & R



Y + WH

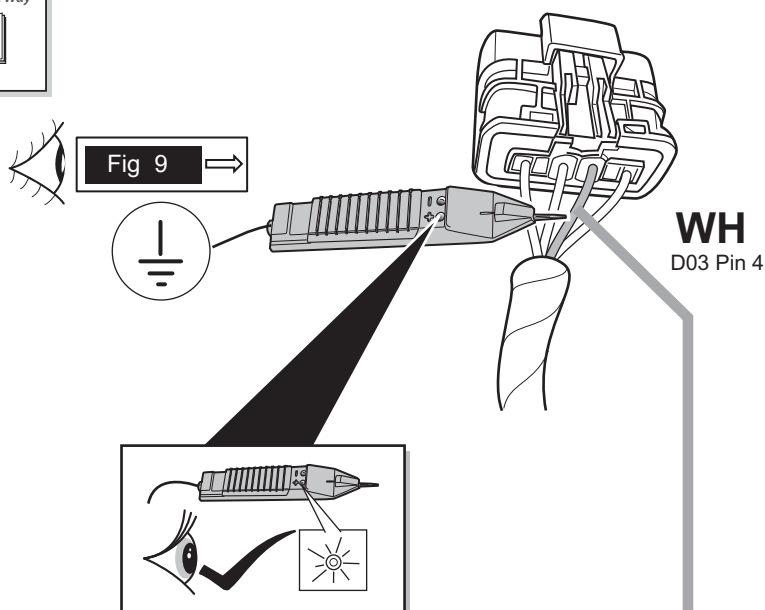

WH
D03 Pin 4

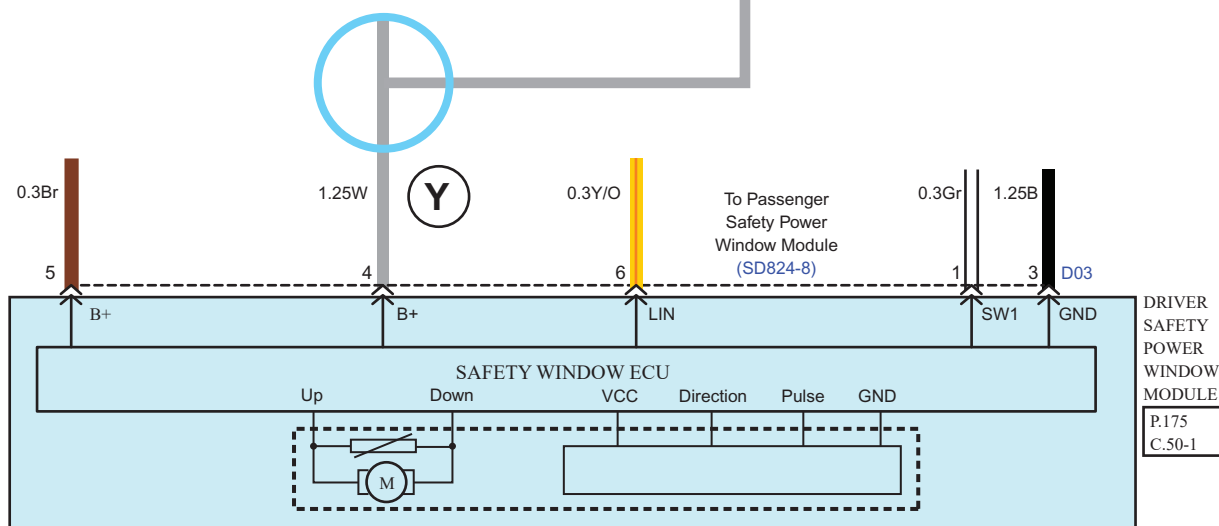

Fig 10

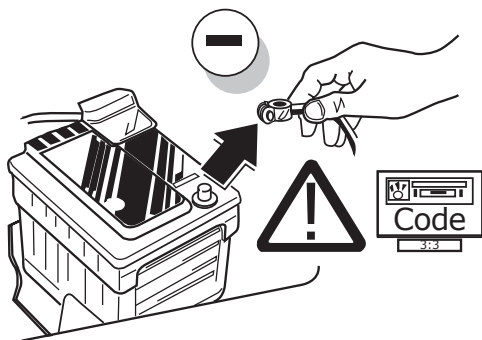

Fig 11

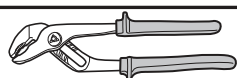
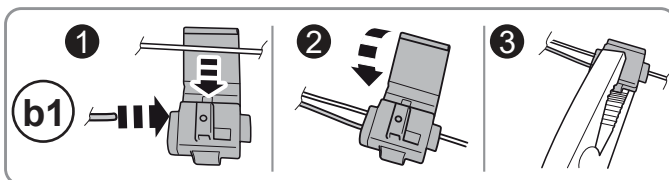
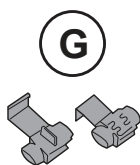
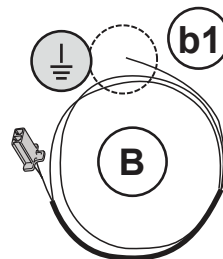
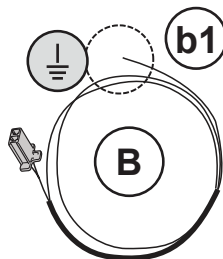
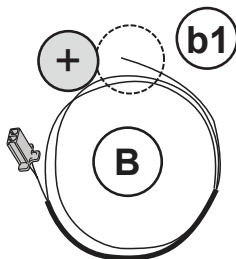
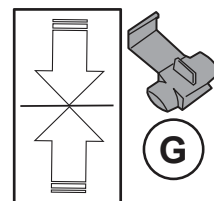
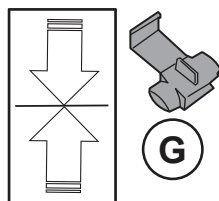
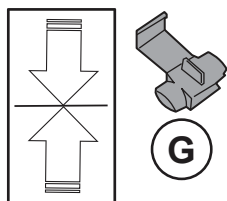
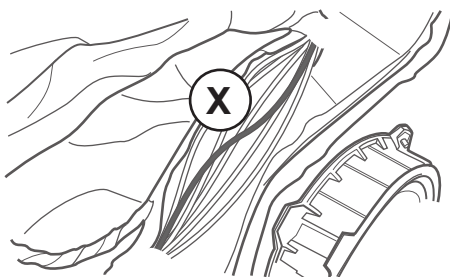
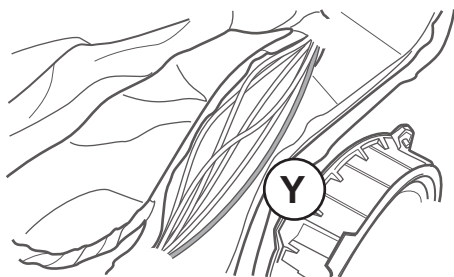
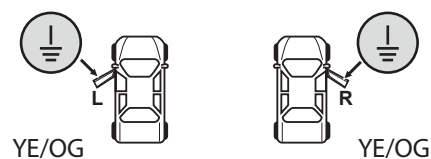
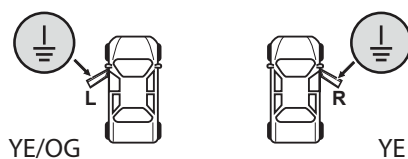
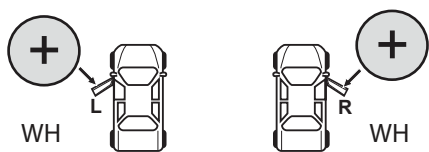

Fig 12



L & R

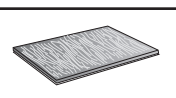
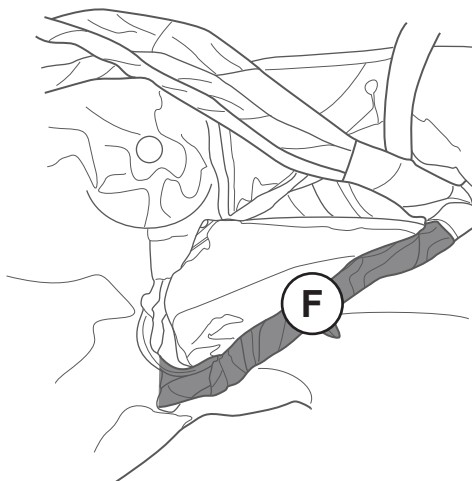
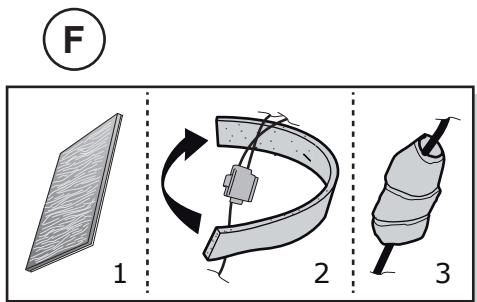
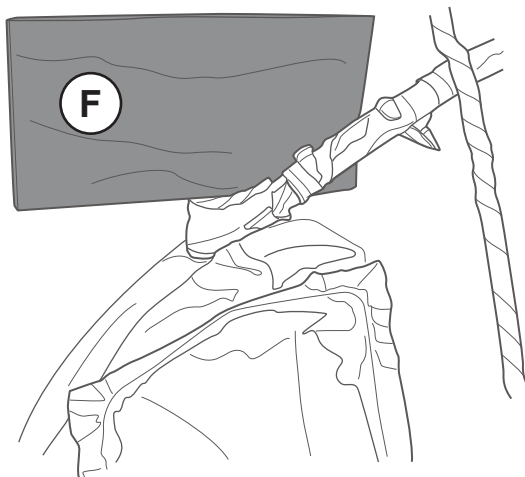

Fig 13

L & R

1



2

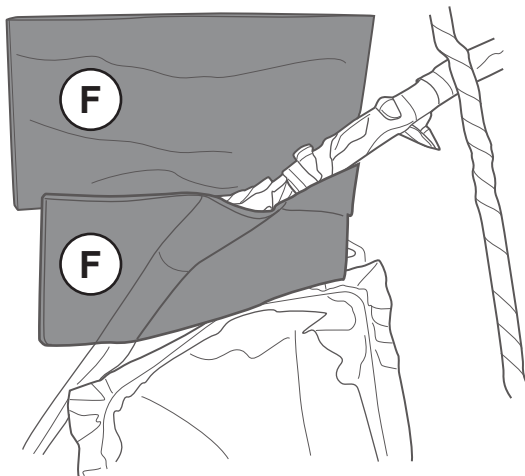

Fig 14

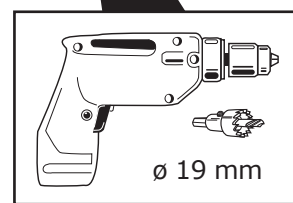
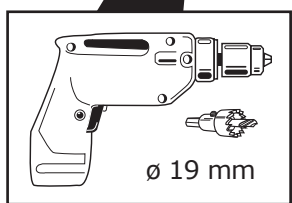
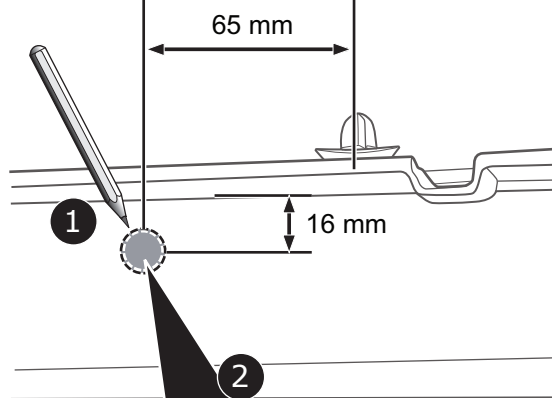
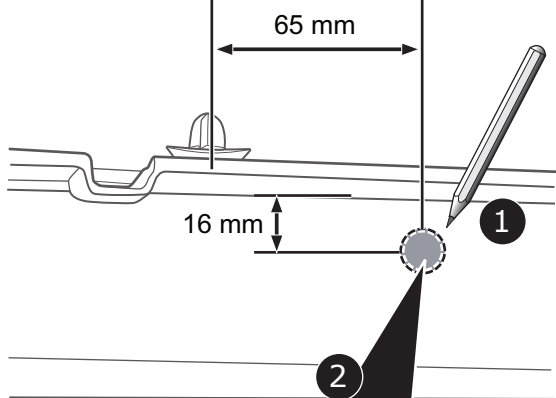
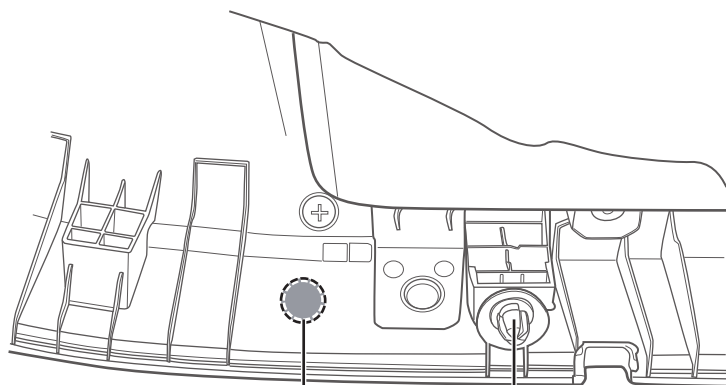
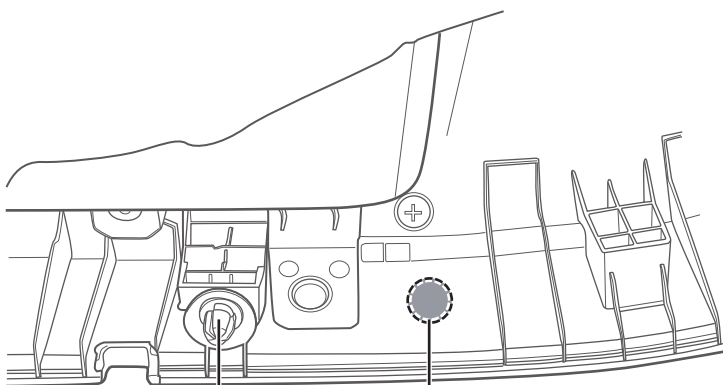
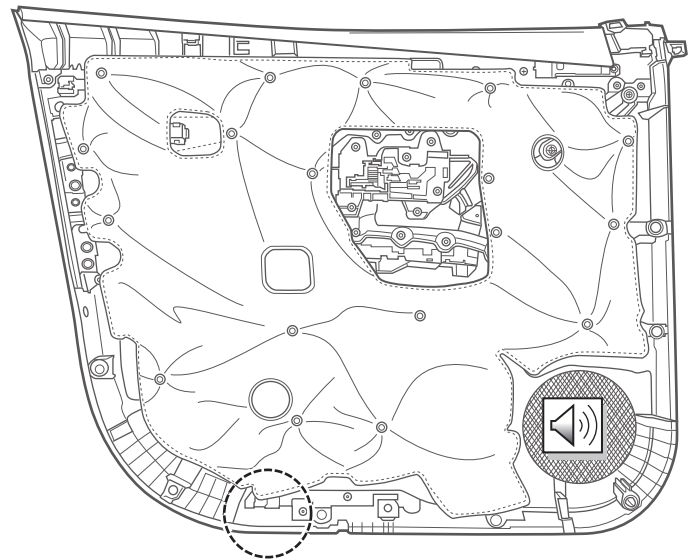
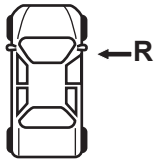
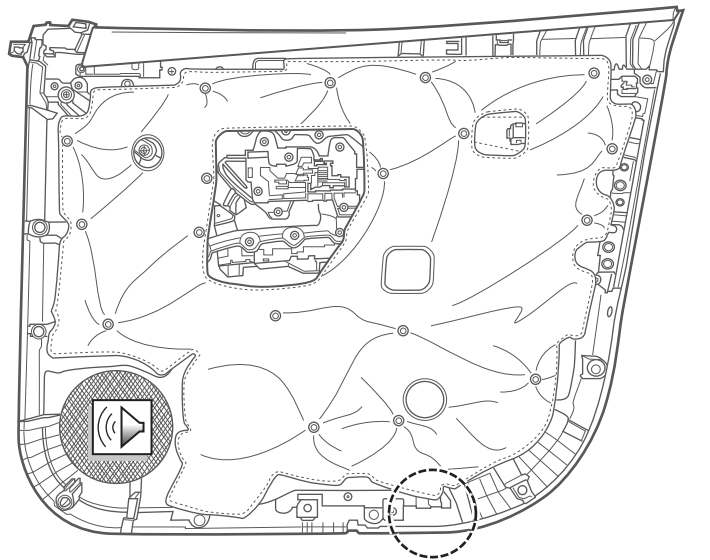
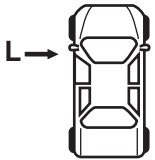
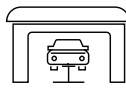
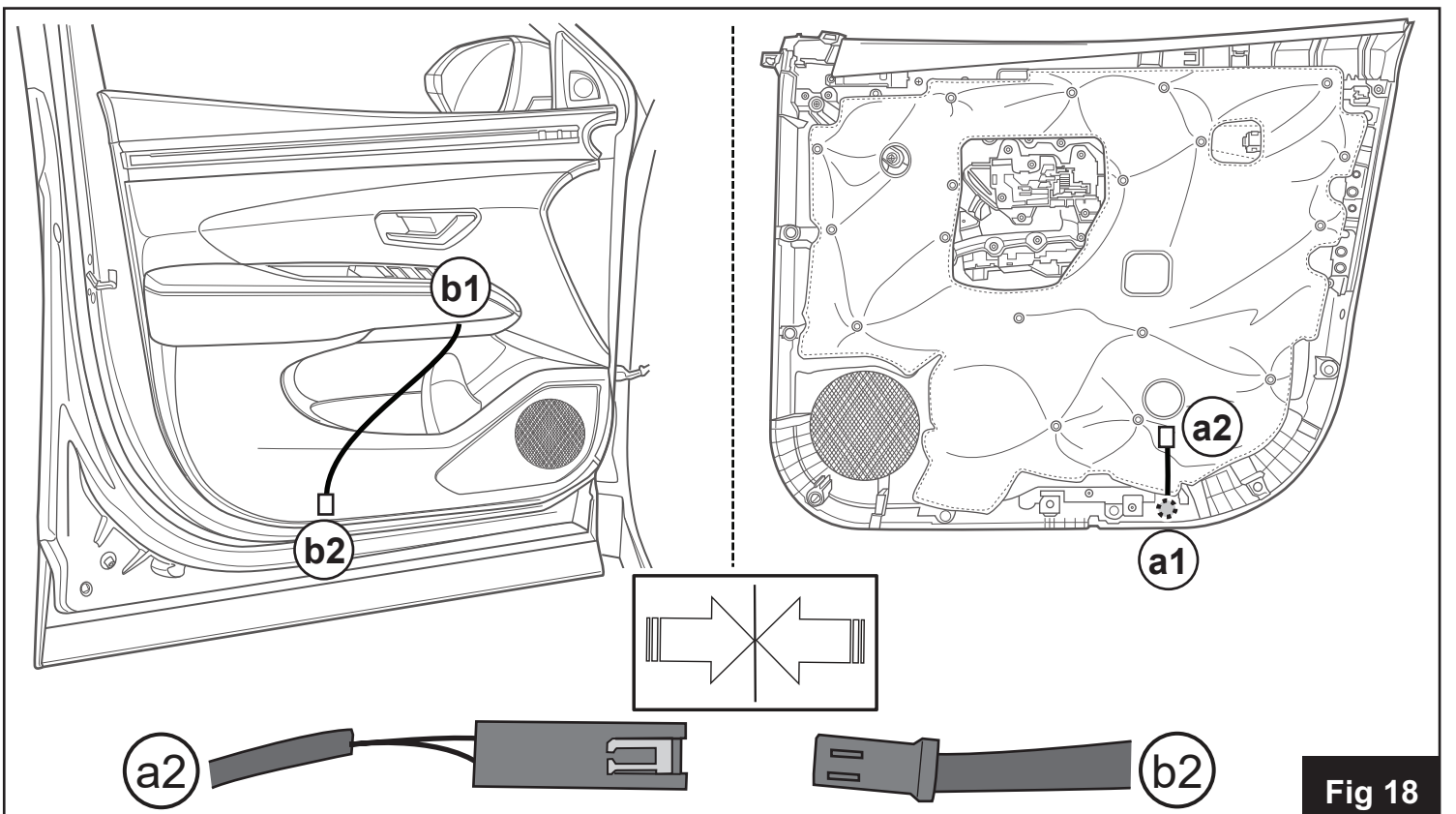
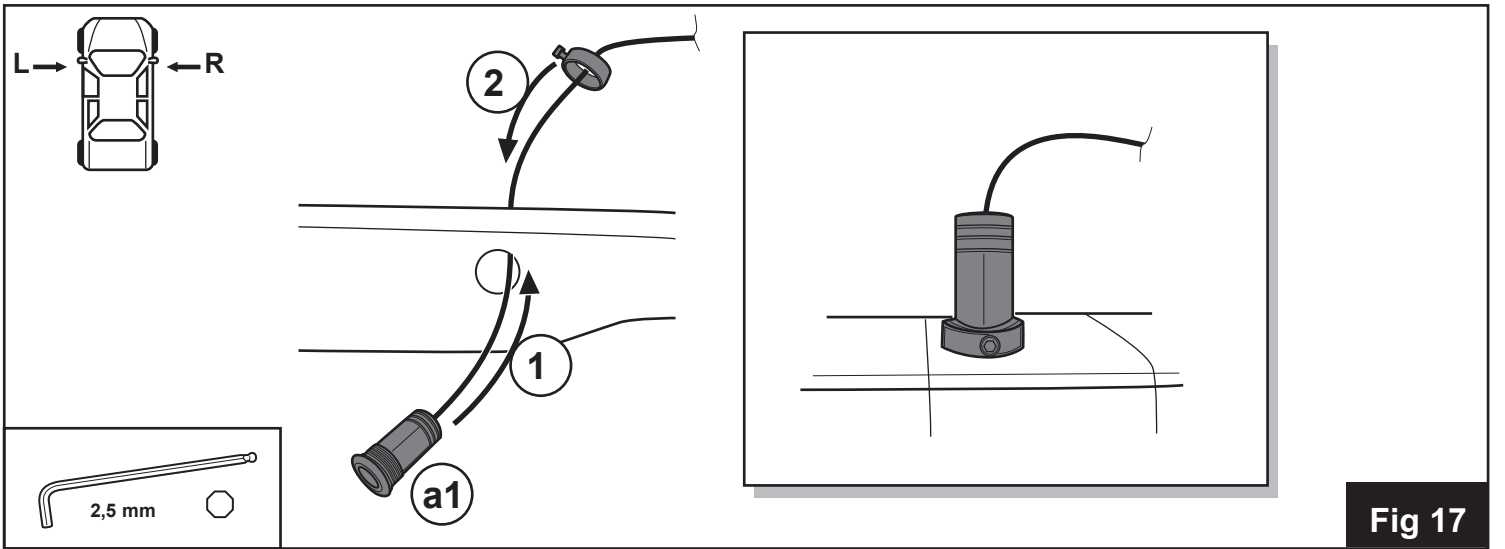
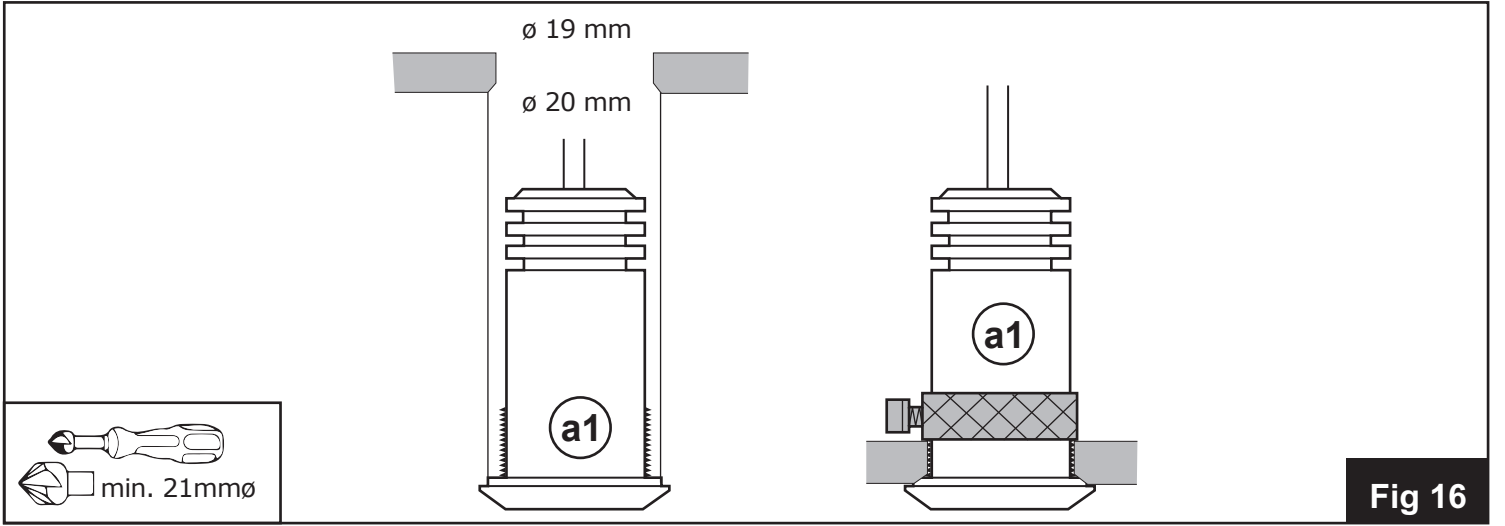
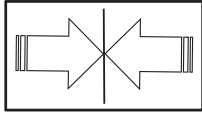

Fig 15





L & R



1

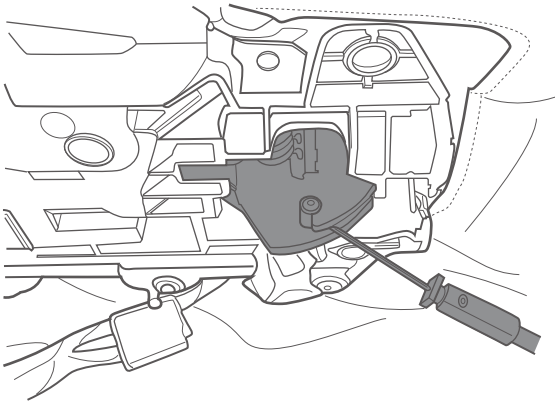

2

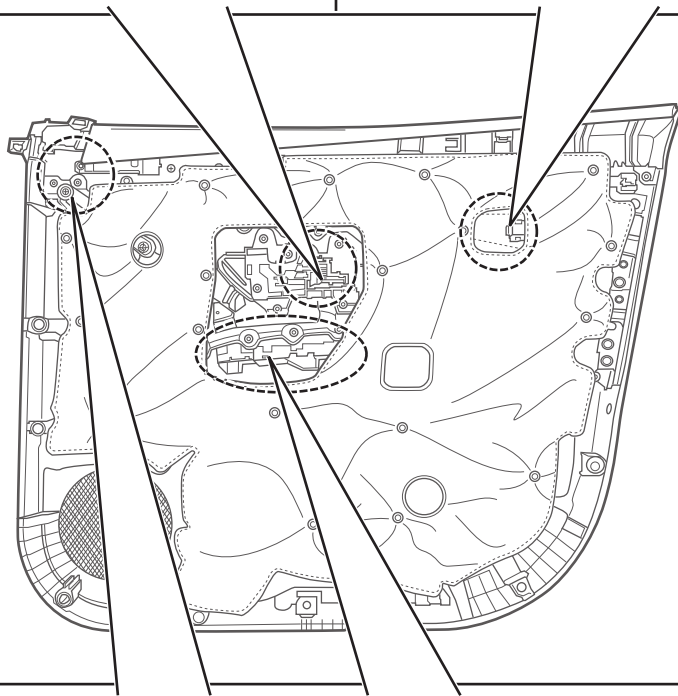
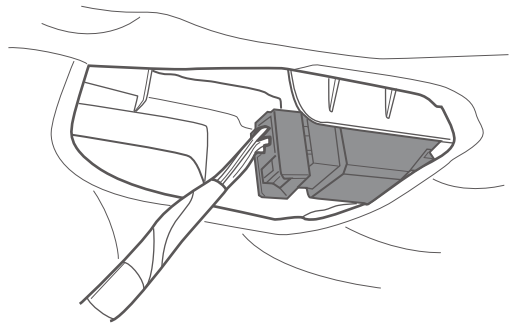

3

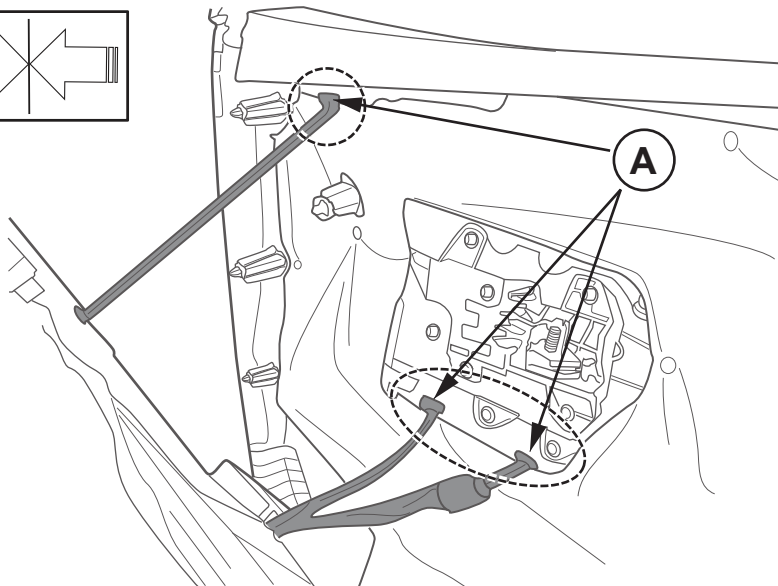
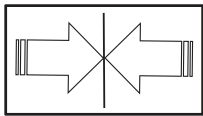

Fig 19



L & R

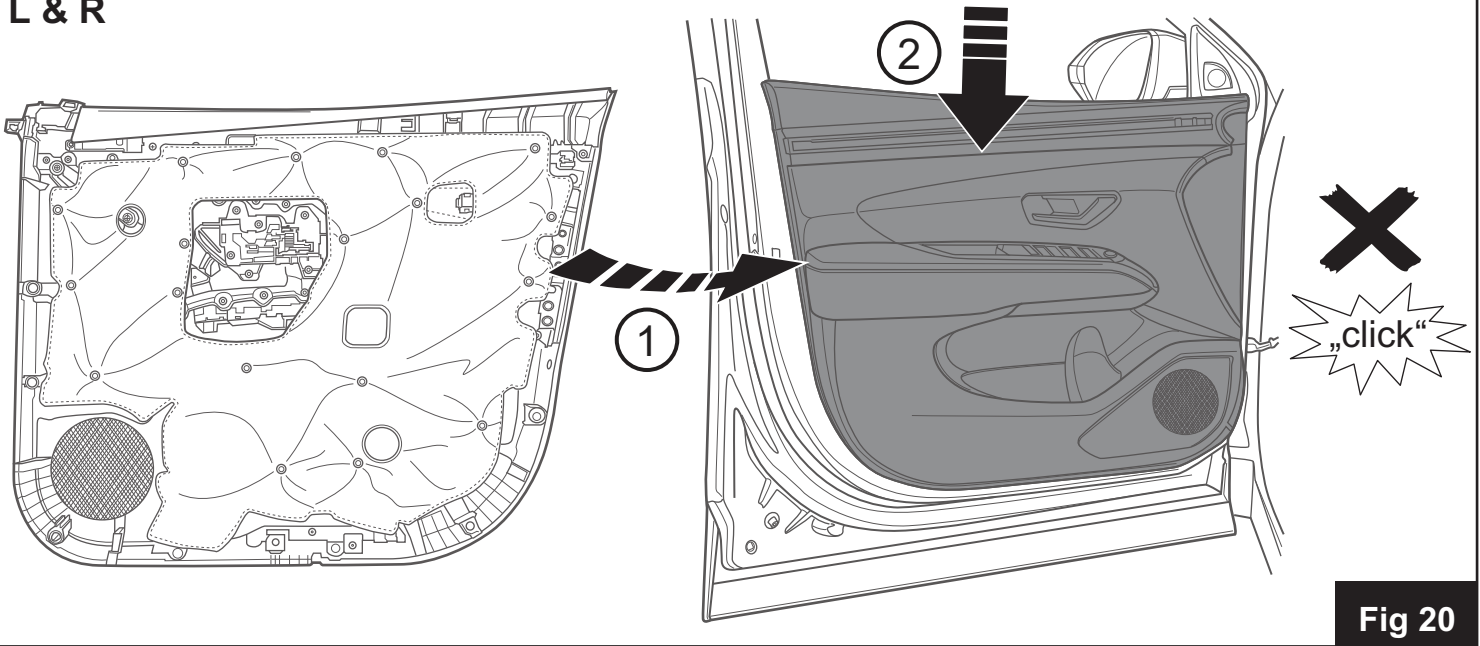

Fig 20

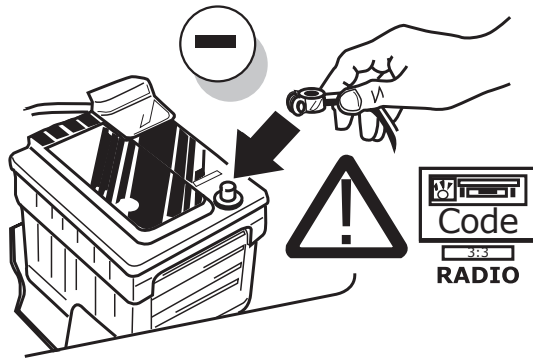

Fig 21

L & R

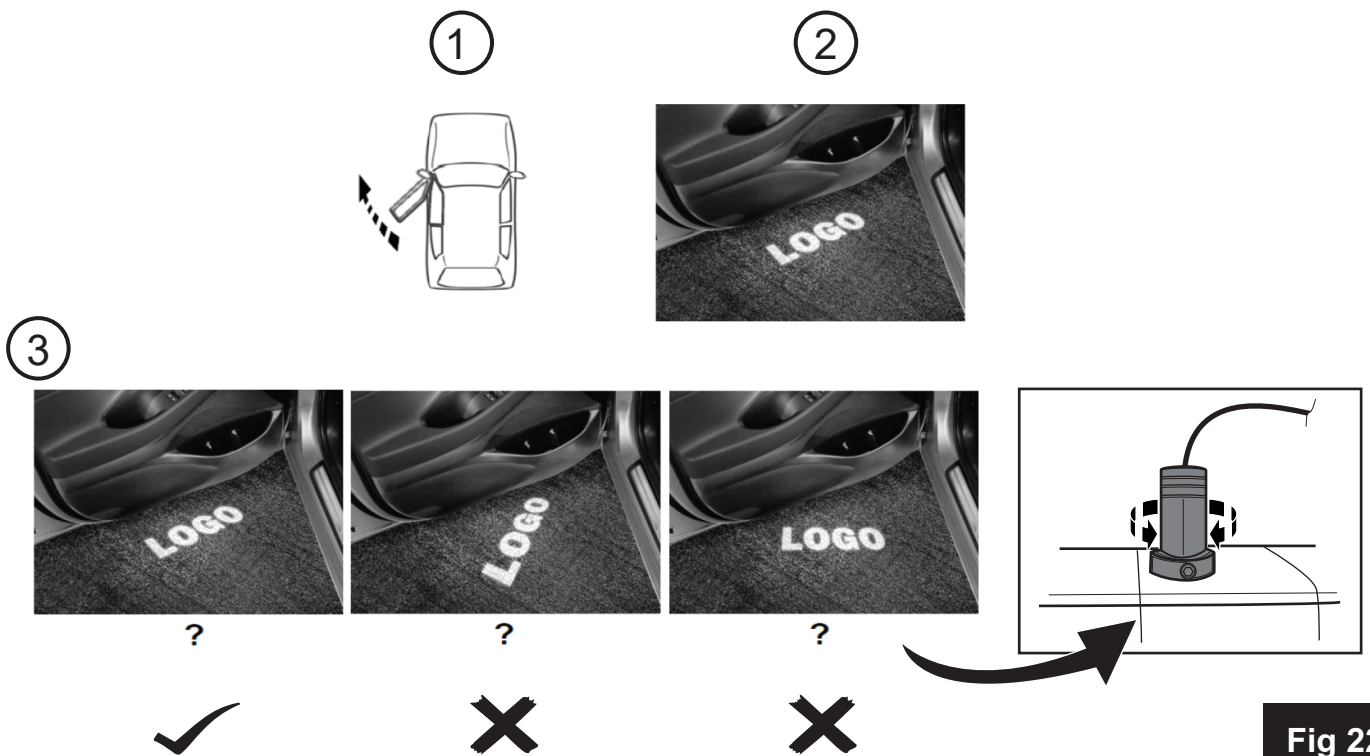

Fig 22



L & R

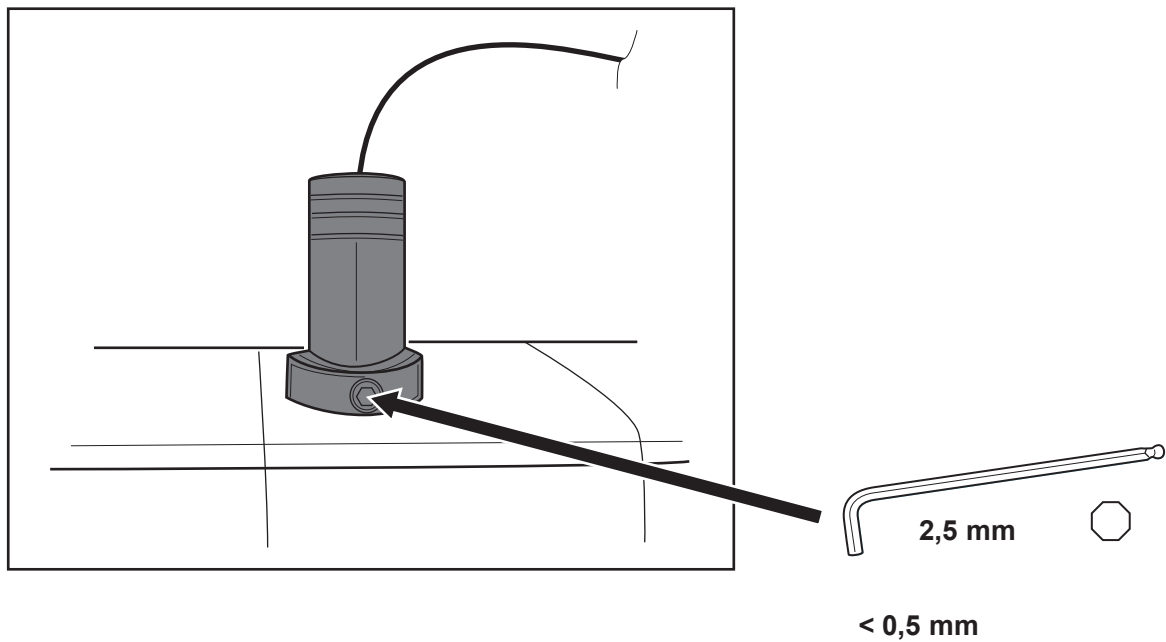
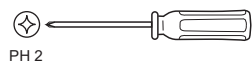
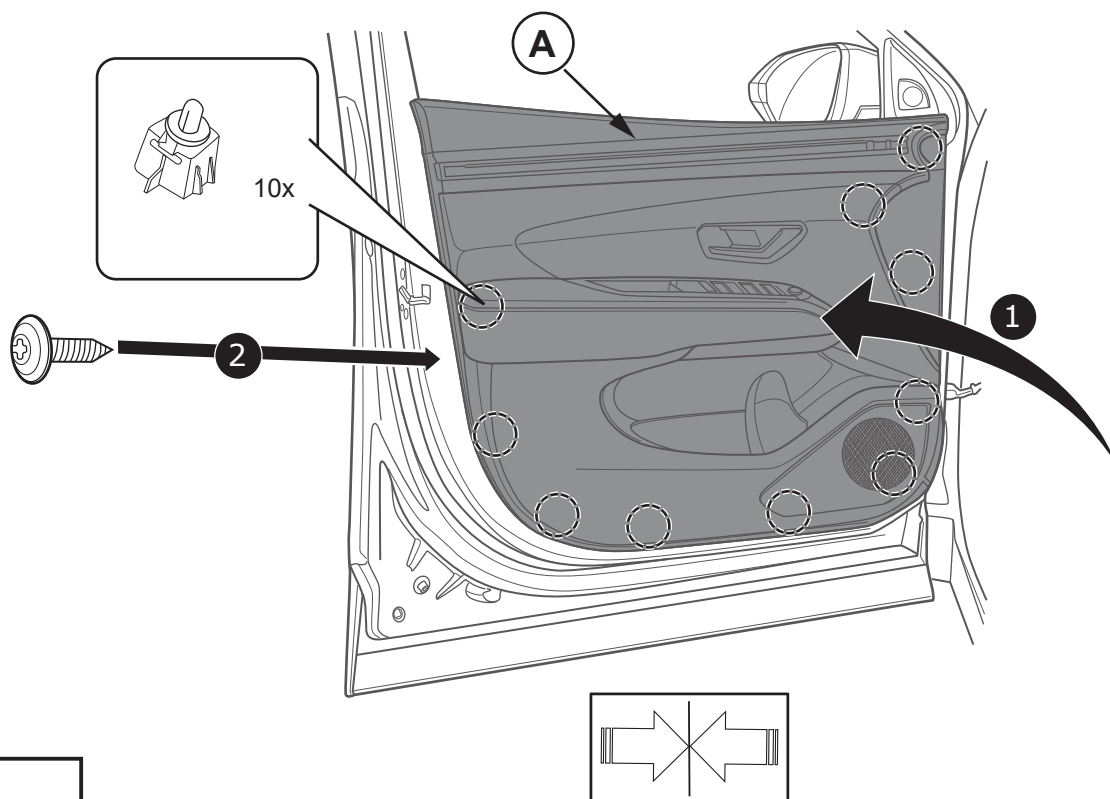

Fig 23

L & R



PH 2

Fig 24



L & R

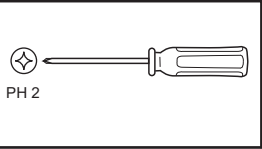
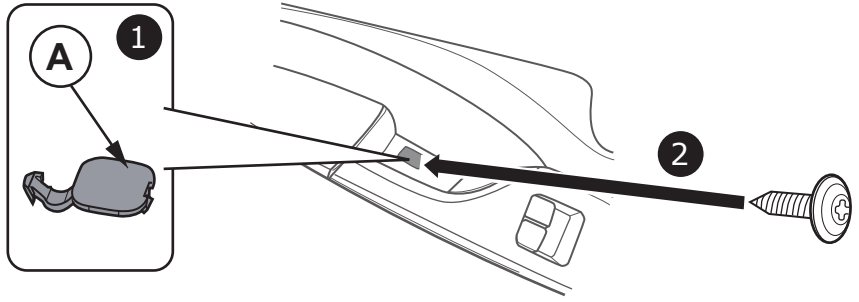
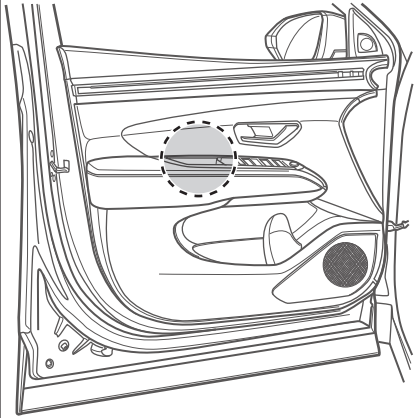

Fig 25

L & R

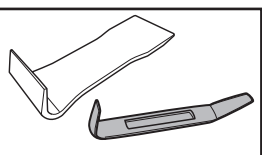
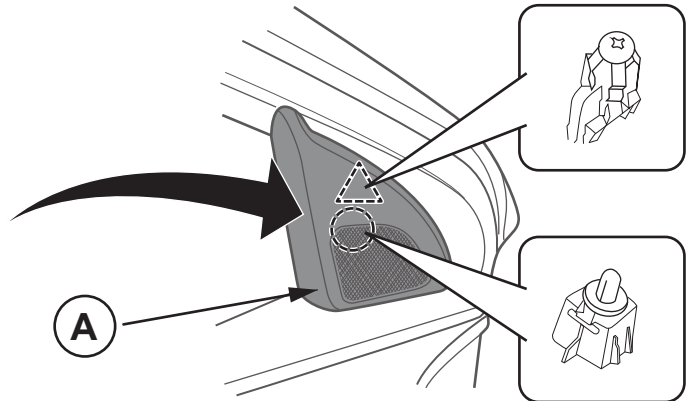
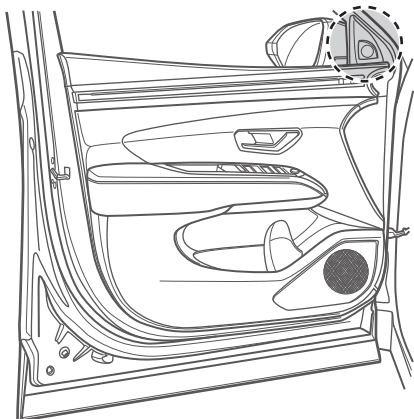

Fig 26









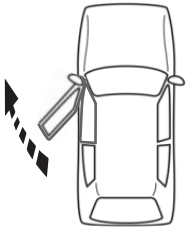
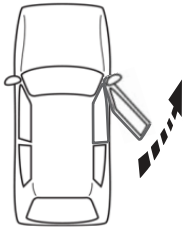
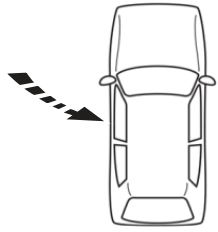
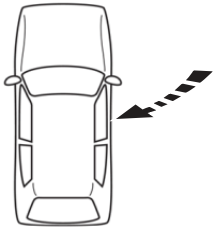

①	②	③	④
			
			
			

Fig 27